

Steel Storage Equipment

Price List

Box Edge Plus[®]
Steel Shelving



Rivet-Span[®]



Automotive Storage

● ● ● ● ●
SOUTHWEST **SOLUTIONS** GROUP
business organization systems



Shop Equipment



STEEL SHELVING

HD DRAWERS

RTA STORAGE CABINETS

MODULAR DRAWERS

RIVET-SPAN[®]

SLOTTED ANGLE

AUTOMOTIVE STORAGE

RECORDS STORAGE

SHOP EQUIPMENT

Table of Contents

ORDERING INFORMATION	3
BOX EDGE PLUS® STEEL SHELVING	
Shelving Units	4 - 5
Shelving Components	6 - 10
Shelving Specifications and Bracing	10 - 11
Multi-Level Shelving	12 - 13
HD DRAWERS	
General Information	14
Preconfigured Units	15 - 21
Components	22
RTA STORAGE CABINETS and RTA CLIP-TYPE SHELVING	23
MODULAR DRAWERS	
Preconfigured Units	24 - 28
Drawer Layout and Dimensional Information	29 - 30
Components	31 - 33
Drawer Kits	34 - 38
RIVET-SPAN®	
Bulk Storage Units	40
Shelf Units	41
Rivet-Span Components	42 - 43
Rivet-Span Specifications	44 - 45
SLOTTED ANGLE	46
FLEXI-BINS®	47
AUTOMOTIVE STORAGE UNITS	48 - 51
RECORD HOLDERS RECORD STORAGE UNITS	52 - 53
SHOP EQUIPMENT	
Tech Benches	54
Work Bench Units	55 - 57
Work Bench Components	58 - 60
Desks and Carts	61

Ordering Information

HOW TO ORDER

Orders may be placed by authorized Borroughs dealers.

Mail: **Borroughs Corporation**
Attn: Storage Products Order Entry
3002 N. Burdick Street
Kalamazoo, MI 49004-3483
Storage Products: 1-800-748-0227 ☐ Fax: 1-269-342-4161
(Orders Only) Fax: 1-800-375-1327

All orders must show quantity, catalog number, description, color and customer purchase order number. Borroughs does not assume responsibility for errors on orders not submitted in writing.

ACKNOWLEDGMENT

Borroughs will issue a written Order Acknowledgment for each order accepted. Estimated ship dates are stated on Acknowledgments. All orders are considered correct as acknowledged. **Order changes may affect estimated ship dates!** Customer should review Acknowledgment promptly and notify Borroughs of any error. Hard copy Acknowledgments will not be issued until all the engineering has been completed. Please check and review the current status of the order on the Dealer site prior to the hard copy being mailed.

ORDER CHANGES / CANCELLATION

Order changes/cancellations always must be confirmed to Borroughs in writing. Borroughs will issue a new Order Acknowledgment for each change (see Acknowledgment). Lead times may be changed by Borroughs if necessary to accommodate order changes.

Orders can be cancelled without penalty prior to their production. If production has begun, the following conditions apply:

- **A cancellation fee equal to 20% of the net order amount will be assessed for standard products, and**
- **Custom product orders cannot be cancelled if production has begun, and**
- **Custom color orders cannot be cancelled if painted, and**
- **Customer must compensate Borroughs for special parts or materials purchased by Borroughs to produce an order.**

SMALL / MINIMUM ORDER POLICY

Borroughs has a \$75.00 net, plus shipping costs, minimum charge for any order processed.

INSTOCK QUICK SHIP PROGRAM

All items listed in bold, italic print with a bullet [*] preceding the part number are InStock at our Kalamazoo warehouse. Some quantity restrictions apply. Please call Customer Service for immediate order assistance.

SPECIAL MARKING AND PACKAGING

Custom crating, marking, palletizing or export packing is subject to special pricing; and quotations must be made in advance of order placement. Contact Borroughs' Customer Service to determine exact charges.

SHIPMENT TERMS

All orders will be shipped F.O.B. shipping point. Shipments will be "best way" with freight charged collect. Customer may request that freight be prepaid and added to the invoice.

Special carrier or special delivery arrangements can be accommodated. These should be requested in writing as part of the order. Special packaging costs, such as pallets, will be purchaser's responsibility. Orders requesting customer pickup will be accommodated; however, Borroughs reserves the right to ship orders at customer expense if customer fails to take product on the agreed date.

PAYMENT TERMS

1.5% - 10 days; net 30 days. (Different terms may be applied outside continental U.S.). No cash discounts on freight, taxes or services. A 1-1/2% per month finance charge will be added to all unpaid balances after 30 days.

DAMAGED SHIPMENTS

Responsibility - Delivery to the carrier shall constitute delivery to the customer. Borroughs' liability ends upon delivery of products to the carrier. Goods are shipped at the customer's risk. All claims for product lost or damage in transit shall be made by the customer.

Visible Damage - Should be noted on the freight bill and acknowledged by the driver's signature.

Concealed Damage - Notify the freight agent if concealed damage is found within 15 days of delivery. Request an inspection. An inspection is necessary for filing a claim.

RETURN SHIPMENTS

Return shipments may be authorized within 60 days of original shipment. You must have written authorization from Borroughs prior to any return. Authorized returns must be packaged properly using original cartons. They are to be shipped with freight prepaid by customer.

All returns are subject to a 25% restocking charge for InStock items or a 30% restocking charge for non-stocked items. Custom product items, including custom colors, may not be returned. All returns subject to any reconditioning charges determined necessary by Borroughs upon inspection of the returned goods.

PRICES

Prices in this price list supersede all previous prices and are in effect as of the date of this publication. Prices are subject to change without notice.

NOT OFFER TO SELL

Possession of this price list is not to be construed as an offer to sell the products listed. Borroughs reserves the right to discontinue any item in this list without notice. Borroughs reserves the right to change material and design specifications at any time, and without obligation to make corresponding changes in products manufactured previously.

TAXES

Any manufacturer's sales or excise tax, or any other tax or government charge now or hereafter levied upon the product, sale, use or shipment of goods shall, at the Company's options, be charged to the customer.

WARRANTY

Borroughs Corporation extends to the original purchaser from the date of purchase a 5-year limited warranty against manufacturing defects in material and workmanship.

If a Borroughs product fails to perform because of a manufacturing defect, Borroughs will examine it. If found defective, it will be repaired or replaced at our option. This warranty applies only to Borroughs products acquired directly from Borroughs Corporation or from Authorized Borroughs Dealers.

This warranty does not apply to any product which has been subject to misuse, negligence, or accident; has been damaged in shipment, storage, or installation; has been misapplied or has been modified or repaired by unauthorized persons or been repaired with non-standard Borroughs replacement parts. This warranty specifically excludes claims for indirect, incidental, or consequential damages arising in any way from a product defect. This warranty is exclusive, and exists in lieu of all other warranties, either expressed or implied.

This warranty gives you specific legal rights; you may also have other rights which may vary from state to state.

Contact your Borroughs Selling Dealer, to obtain warranty service. You must make a written claim. Provide a copy of your purchase record and a written description of the warranty problem with your claim.

If you are unable to contact your Dealer, contact: Borroughs Corporation, Customer Service Manager, 3002 N. Burdick St., Kalamazoo, MI 49004-3483.

Color Policy

Product	#065 Industrial Gray	#445 White	#C386 Red	#B504 Blue	#F604 Pebble	#161 Mist Gray	#040 Black
BOX EDGE PLUS® Steel Shelving	Std.	Std.	Std.	Std.	Std.	Std.	Std.
HD Drawers	Std.	Std.	Std.	Std.	Std.	Std.	Std.
Commercial Grade Steel Shelving (RTA Clip-Type)	Std.	N/A	N/A	N/A	N/A	N/A	N/A
FLEXI-BINS®	Std.	Std.	Std.	Std.	Std.	Std.	Std.
RIVET-SPAN®	Std.	Std.	Std.	Std.	Std.	Std.	Std.
Modular Drawers	Std.	Std.	Std.	Std.	Std.	Std.	Std.
Slotted Angle	Std.	Std.	Std.	Std.	Std.	Std.	Std.
Shop Equipment	Std.	Std.	Std.	Std.	Std.	Std.	Std.
Utility Carts (Commercial only)	Std.	N/A	N/A	N/A	N/A	N/A	N/A

NOTE: Flexi-Bin Back Panels, Flexi-Bin Drawer Dividers and Shelf Box Partitions are #445 White.

Custom Color Upcharge: Consult Borroughs Customer Service for availability of colors other than those listed above. Custom color orders, if accepted, will be subject to manufacturing schedules and an upcharge based upon material, quantity, and color. Samples must be approved in writing before order is accepted for firm shipping date. Custom color orders are not subject to cancellation nor return and must be one order and delivery location.

Steel Shelving Units

STEEL SHELVING

Catalog No.	List Price	Wt.	Size	Wt.	List Price	Catalog No.
Open Type With Plus 1 Shelves						
Starter			5 Shelves		Adder	
P1-1000-3	\$186.20	71	36" x 12" x 7'3"/87"	68	\$177.88	P1-1001-3
P1-1000-4	217.04	84	48" x 12" x 7'3"/87"	82	208.72	P1-1001-4
P1-1004-3	218.22	88	36" x 18" x 7'3"/87"	83	209.60	P1-1005-3
P1-1006-3	252.90	102	36" x 24" x 7'3"/87"	99	243.84	P1-1007-3
Starter			6 Shelves		Adder	
P1-1012-3	207.28	79	36" x 12" x 7'3"/87"	76	\$197.48	P1-1013-3
P1-1012-4	242.60	95	48" x 12" x 7'3"/87"	93	234.26	P1-1013-4
P1-1016-3	244.10	97	36" x 18" x 7'3"/87"	94	235.48	P1-1017-3
P1-1018-3	285.56	116	36" x 24" x 7'3"/87"	113	276.52	P1-1019-3
Starter			7 Shelves		Adder	
P1-1024-3	\$225.38	86	36" x 12" x 7'3"/87"	84	\$217.08	P1-1025-3
P1-1024-4	268.12	105	48" x 12" x 7'3"/87"	103	259.80	P1-1025-4
P1-1028-3	269.98	107	36" x 18" x 7'3"/87"	105	261.36	P1-1029-3
P1-1030-3	318.20	130	36" x 24" x 7'3"/87"	127	309.18	P1-1031-3

Catalog No.	List Price	Wt.	Size	Wt.	List Price	Catalog No.
Open Type						
Starter			5 Shelves		Adder	
1000-3	\$199.80	71	36" x 12" x 7'3"/87"	68	\$191.48	1001-3
1000-4	229.06	84	48" x 12" x 7'3"/87"	82	220.76	1001-4
1004-3	235.22	88	36" x 18" x 7'3"/87"	83	226.60	1005-3
1004-4	282.96	103	48" x 18" x 7'3"/87"	101	274.32	1005-4
1006-3	270.94	102	36" x 24" x 7'3"/87"	199	261.94	1007-3
1006-4	334.26	126	48" x 24" x 7'3"/87"	123	325.22	1007-4
Starter			6 Shelves		Adder	
1012-3	\$222.12	79	36" x 12" x 7'3"/87"	76	\$213.80	1013-3
1012-4	257.04	95	48" x 12" x 7'3"/87"	93	248.70	1013-4
1016-3	264.52	97	36" x 18" x 7'3"/87"	94	255.88	1017-3
1016-4	321.54	117	48" x 18" x 7'3"/87"	115	312.92	1017-4
1018-3	307.22	116	36" x 24" x 7'3"/87"	113	298.18	1019-3
1018-4	382.94	145	48" x 24" x 7'3"/87"	142	373.90	1019-4
Starter			7 Shelves		Adder	
1024-3	\$244.44	85	36" x 12" x 7'3"/87"	84	\$236.12	1025-3
1024-4	284.98	105	48" x 12" x 7'3"/87"	103	276.64	1025-4
1028-3	293.80	107	36" x 18" x 7'3"/87"	105	285.16	1029-3
1028-4	360.14	131	48" x 18" x 7'3"/87"	127	351.52	1029-4
1030-3	343.48	130	36" x 24" x 7'3"/87"	127	334.45	1031-3
1030-4	431.62	163	48" x 24" x 7'3"/87"	160	422.62	1031-4
Starter			8 Shelves		Adder	
1036-3	\$266.76	94	36" x 12" x 7'3"/87"	92	\$258.44	1037-3
1036-4	312.92	116	48" x 12" x 7'3"/87"	114	304.60	1037-4
1040-3	323.08	118	36" x 18" x 7'3"/87"	116	314.44	1041-3
1040-4	398.78	146	48" x 18" x 7'3"/87"	144	390.12	1041-4
1042-3	379.74	144	36" x 24" x 7'3"/87"	141	370.74	1043-3
1042-4	480.34	182	48" x 24" x 7'3"/87"	179	471.32	1043-4

Catalog No.	List Price	Wt.	Size	Wt.	List Price	Catalog No.
Closed Type - Without Backs						
Starter			5 Shelves		Adder	
2000-3	\$230.16	76	36" x 12" x 7'3"/87"	71	\$206.66	2001-3
2000-4	259.44	90	48" x 12" x 7'3"/87"	85	235.94	2001-4
2004-3	287.98	98	36" x 18" x 7'3"/87"	90	252.98	2005-3
2004-4	335.72	116	48" x 18" x 7'3"/87"	107	300.72	2005-4
2006-3	340.76	114	36" x 24" x 7'3"/87"	102	296.84	2007-3
2006-4	404.06	145	48" x 24" x 7'3"/87"	133	360.12	2007-4
Starter			6 Shelves		Adder	
2012-3	\$252.48	84	36" x 12" x 7'3"/87"	79	\$228.98	2013-3
2012-4	287.38	100	48" x 12" x 7'3"/87"	95	263.90	2013-4
2016-3	317.26	109	36" x 18" x 7'3"/87"	100	282.26	2017-3
2016-4	374.30	130	48" x 18" x 7'3"/87"	121	339.30	2017-4
2018-3	377.04	120	36" x 24" x 7'3"/87"	116	333.10	2019-3
2018-4	452.76	164	48" x 24" x 7'3"/87"	141	408.82	2019-4
Starter			7 Shelves		Adder	
2024-3	\$274.80	92	36" x 12" x 7'3"/87"	87	\$251.30	2025-3
2024-4	315.34	111	48" x 12" x 7'3"/87"	106	291.84	2025-4
2028-3	346.56	120	36" x 18" x 7'3"/87"	111	311.54	2029-3
2028-4	412.90	144	48" x 18" x 7'3"/87"	136	377.88	2029-4
2030-3	413.28	142	36" x 24" x 7'3"/87"	130	369.36	2031-3
2030-4	501.44	182	48" x 24" x 7'3"/87"	170	457.52	2031-4
Starter			8 Shelves		Adder	
2036-3	\$297.10	100	36" x 12" x 7'3"/87"	95	\$273.62	2037-3
2036-4	343.28	121	48" x 12" x 7'3"/87"	116	319.78	2037-4
2040-3	375.82	131	36" x 18" x 7'3"/87"	122	340.80	2041-3
2040-4	451.50	159	48" x 18" x 7'3"/87"	150	416.48	2041-4
2042-3	449.56	156	36" x 24" x 7'3"/87"	144	405.62	2043-3
2042-4	550.14	201	48" x 24" x 7'3"/87"	189	506.22	2043-4

Catalog No.	List Price	Wt.	Size	Wt.	List Price	Catalog No.
Closed Type - With Backs (backs painted #445 White)						
Starter			5 Shelves		Adder	
3000-3	\$297.76	96	36" x 12" x 7'3"/87"	92	\$274.24	3001-3
3000-4	353.06	117	48" x 12" x 7'3"/87"	112	329.54	3001-4
3004-3	355.56	119	36" x 18" x 7'3"/87"	110	320.58	3005-3
3004-4	429.30	143	48" x 18" x 7'3"/87"	135	394.32	3005-4
3006-3	408.34	142	36" x 24" x 7'3"/87"	130	364.42	3007-3
3006-4	497.66	173	48" x 24" x 7'3"/87"	160	453.74	3007-4
Starter			6 Shelves		Adder	
3012-3	\$320.08	104	36" x 12" x 7'3"/87"	99	\$296.56	3013-3
3012-4	380.98	128	48" x 12" x 7'3"/87"	123	357.48	3013-4
3016-3	384.86	130	36" x 18" x 7'3"/87"	121	349.84	3017-3
3016-4	467.90	158	48" x 18" x 7'3"/87"	149	432.90	3017-4
3018-3	444.62	156	36" x 24" x 7'3"/87"	144	400.68	3019-3
3018-4	546.38	191	48" x 24" x 7'3"/87"	179	502.40	3019-4
Starter			7 Shelves		Adder	
3024-3	\$342.40	112	36" x 12" x 7'3"/87"	107	\$318.88	3025-3
3024-4	408.92	138	48" x 12" x 7'3"/87"	123	385.42	3025-4
3028-3	414.14	140	36" x 18" x 7'3"/87"	121	379.12	3029-3
3028-4	506.52	163	48" x 18" x 7'3"/87"	149	471.48	3029-4
3030-3	480.88	170	36" x 24" x 7'3"/87"	144	436.96	3031-3
3030-4	595.06	210	48" x 24" x 7'3"/87"	179	551.12	3031-4
Starter			8 Shelves		Adder	
3036-3	\$364.72	120	36" x 12" x 7'3"/87"	115	\$341.20	3037-3
3036-4	436.86	149	48" x 12" x 7'3"/87"	144	413.38	3037-4
3040-3	443.42	151	36" x 18" x 7'3"/87"	142	408.38	3041-3
3040-4	545.12	186	48" x 18" x 7'3"/87"	177	510.10	3041-4
3042-3	517.14	184	36" x 24" x 7'3"/87"	172	473.22	3043-3
3042-4	643.72	228	48" x 24" x 7'3"/87"	216	599.82	3043-4

All units shown are 36" or 48" wide and 7'3"/87" high.
 Other sizes available upon request.
 All units shipped K.D.
 All units, unless otherwise stated, include PLUS 2 shelves and #445 White backs.
 Hardware included in price.

Steel Shelving Units

STEEL SHELVING

Catalog No.	List Price	Wt.	Size	Wt.	List Price	Catalog No.
Bin Type (backs painted #445 White)						
Starter					Adder	
4012	\$390.22	119	36" x 12" x 7'3"/87"	114	\$366.72	4013
4016	479.42	152	36" x 18" x 7'3"/87"	143	444.40	4017
4018	566.08	186	36" x 24" x 7'3"/87"	174	522.14	4019
Starter					Adder	
4036	\$463.26	142	36" x 12" x 7'3"/87"	138	\$439.74	4037
4040	566.88	185	36" x 18" x 7'3"/87"	176	531.86	4041
4042	678.34	228	36" x 24" x 7'3"/87"	216	634.42	4043
Starter					Adder	
4048	\$518.84	157	36" x 12" x 7'3"/87"	152	\$495.34	4049
4052	633.70	206	36" x 18" x 7'3"/87"	197	598.70	4053
4054	787.98	257	36" x 24" x 7'3"/87"	244	744.06	4055
Starter					Adder	
4112	\$490.98	142	36" x 12" x 7'3"/87"	137	\$467.46	4113
4116	580.16	174	36" x 18" x 7'3"/87"	166	545.16	4117
4118	666.80	208	36" x 24" x 7'3"/87"	196	622.88	4119
Starter					Adder	
4124	\$466.48	152	36" x 12" x 7'3"/87"	147	\$483.28	4125
4128	600.64	188	36" x 18" x 7'3"/87"	179	565.64	4129
4130	696.96	227	36" x 24" x 7'3"/87"	214	653.04	4131
Starter					Adder	
4148	\$605.60	178	36" x 12" x 7'3"/87"	173	\$582.12	4149
4152	720.48	228	36" x 18" x 7'3"/87"	219	685.46	4153
4154	874.76	278	36" x 24" x 7'3"/87"	266	830.83	4155
Starter					Adder	
4172	\$715.54	202	36" x 12" x 7'3"/87"	197	\$692.02	4173
4176	848.92	262	36" x 18" x 7'3"/87"	253	813.92	4177
4178	1046.24	322	36" x 24" x 7'3"/87"	309	1002.32	4179
Starter					Adder	
4184	\$993.16	252	36" x 12" x 7'3"/87"	247	\$969.66	4185
4188	1175.54	348	36" x 18" x 7'3"/87"	340	1140.54	4189
4190	1475.86	432	36" x 24" x 7'3"/87"	419	1431.94	4191
Starter					Adder	
4206	\$1113.02	263	36" x 12" x 7'3"/87"	259	\$1163.62	4207
4208	1388.34	345	36" x 18" x 7'3"/87"	336	1353.32	4209
4210	1705.64	445	36" x 24" x 7'3"/87"	433	1696.26	4211
Starter					Adder	
4212	\$1967.12	365	36" x 12" x 7'3"/87"	360	\$1943.60	4213
4214	2264.56	481	36" x 18" x 7'3"/87"	472	2229.56	4215
4216	2826.04	590	36" x 24" x 7'3"/87"	577	2782.12	4217
Cabinet Type (backs painted #445 White)						
Starter					Adder	
5012	\$692.52	162	36" x 12" x 7'3"/87"	157	\$669.04	5013
5016	757.30	187	36" x 18" x 7'3"/87"	179	763.12	5017
5018	817.10	214	36" x 24" x 7'3"/87"	201	773.16	5019
Starter					Adder	
5112	\$940.70	169	36" x 12" x 7'3"/87"	164	\$917.20	5113
5116	1005.50	194	36" x 18" x 7'3"/87"	186	970.48	5117
5118	1065.26	221	36" x 24" x 7'3"/87"	208	1021.32	5119

Catalog No.	List Price	Wt.	Size	Wt.	List Price	Catalog No.
Ledge Type (backs painted #445 White)						
Starter					Adder	
6024	\$496.84	156	36" x 12" x 7'3"/87"	149	\$462.70	6025
6028	568.58	185	36" x 18" x 7'3"/87"	173	522.94	6029
6030	635.36	214	36" x 24" x 7'3"/87"	199	580.78	6031
Starter					Adder	
6036	\$928.46	230	36" x 12" x 7'3"/87"	222	\$894.30	6037
6040	1057.86	285	36" x 18" x 7'3"/87"	274	1030.98	6041
6042	1257.74	336	36" x 24" x 7'3"/87"	321	1191.22	6043
Starter					Adder	
6536	\$1161.16	237	36" x 12" x 7'3"/87"	230	\$1127.00	6537
6540	1239.86	268	36" x 18" x 7'3"/87"	257	1194.22	6541
6542	1313.60	301	36" x 24" x 7'3"/87"	286	1259.02	6543
Open Counter Type						
Starter					Adder	
7018	\$210.20	60	36" x 18" x 40"	57	\$201.56	7019
7024	241.90	74	36" x 24" x 40"	71	232.88	7025
7030	286.36	88	36" x 30" x 40"	85	276.82	7031
Starter					Adder	
7118	\$237.12	73	42" x 18" x 40"	70	\$228.50	7119
7124	271.54	86	42" x 24" x 40"	83	262.52	7125
7130	321.74	101	42" x 30" x 40"	98	312.18	7131
Closed Counter Type (backs painted #445 White)						
Starter					Adder	
7518	\$282.32	79	36" x 18" x 40"	76	\$265.78	7519
7524	326.40	96	36" x 24" x 40"	90	303.30	7525
7530	381.58	112	36" x 30" x 40"	105	345.28	7531
Starter					Adder	
7618	\$324.34	95	42" x 18" x 40"	90	\$307.82	7619
7624	371.14	109	42" x 24" x 40"	104	348.02	7625
7630	432.06	127	42" x 30" x 40"	120	403.06	7631
Open Vertical Storage						
Starter					Adder	
8006	\$333.08	89	36" x 12" x 7'3"/87"	87	\$324.74	8007
8008	366.16	99	36" x 18" x 7'3"/87"	97	357.52	8009
8010	398.80	112	36" x 24" x 7'3"/87"	109	389.78	8011
Starter					Adder	
8200	\$295.70	102	36" x 36" x 7'3"/87"	100	\$285.70	8201
Closed Vertical Storage (backs painted #445 White)						
Starter					Adder	
8100	\$403.56	116	36" x 12" x 7'3"/87"	111	\$380.06	8101
8102	470.36	141	36" x 18" x 7'3"/87"	132	435.32	8103
8104	540.70	167	36" x 24" x 7'3"/87"	155	496.78	8105

All units shown, except Counter Type units, are 36" wide and 7'3"/87" high.
 Other sizes available upon request.
 All units shipped K.D.
 Hardware included in price.
 All units priced with PLUS 2 shelves and #445 White backs.

Steel Shelving Components

STEEL SHELVING

Catalog No.	Size	Wt. Each	Qty. Per Pack	List Price
Angle Posts				
09534-099	3'3"/39"	2.7	8	\$7.34
09534-098	4'3"/51"	3.5	8	9.48
09534-097	5'3"/63"	4.2	8	11.68
•09534-096	6'3"/75"	5.2	8	13.56
13112-099	7'0"/84"	5.7	8	15.38
•09534-095	7'3"/87"	5.9	8	15.38
13112-096	8'0"/96"	6.1	8	17.40
•09534-094	8'3"/99"	6.3	8	17.40
•09534-093	9'3"/111"	7.5	8	19.84
•09534-092	10'3"/123"	8.3	8	23.10
09534-091	11'3"/135"	9.8	8	26.04
09534-090	12'3"/147"	10.7	8	28.86
09534-089	13'3"/159"	11.6	8	31.20
09534-088	14'3"/171"	12.2	8	33.34
09534-085	14'6"/174"	12.4	8	34.90
09534-087	15'3"/183"	13.4	8	35.70
09534-086	16'3"/195"	14.5	8	37.98



Commercial Grade Angle Posts

•14398-000	6'0"/72"	3.8	8	\$11.86
•14398-001	7'0"/84"	4.5	8	13.50

Commercial Posts not suited for multi-level or heavy-duty applications. Consult Post Loading Chart for capacities.

Catalog No.	Size	Wt. Each	Qty. Per Pack	List Price
Beaded Posts				
•14933-000	6'3"/75"	10.3	4	\$27.08
•14933-001	7'3"/87"	11.9	4	30.66
14933-015	8'0"/96"	13.4	4	34.76
•14933-002	8'3"/99"	13.5	4	34.76
14933-003	9'3"/111"	15.2	4	39.64
14933-004	10'3"/123"	16.8	4	46.12
14933-008	12'3"/147"	21.4	4	57.72
14933-009	14'3"/171"	24.4	4	66.66
14933-010	16'3"/195"	28.9	4	75.92



Catalog No.	Size (height x depth)	Wt. Each	Qty. Per Pack	List Price
Beaded Post Closed Sides				
14938-000	6'3"/75" x 12"	21.6	4	\$68.52
14938-006	7'3"/87" x 12"	25.0	4	79.90
14938-012	8'3"/99" x 12"	26.5	4	91.24
14938-018	9'3"/111" x 12"	28.5	4	102.80
14938-024	10'3"/123" x 12"	30.5	4	120.00
14938-001	6'3"/75" x 15"	23.1	4	73.38
14938-007	7'3"/87" x 15"	25.5	4	84.98
14938-013	8'3"/99" x 15"	28.7	4	97.84
14938-025	10'3"/123" x 15"	31.5	4	125.78
14938-002	6'3"/75" x 18"	24.7	4	78.18
14938-008	7'3"/87" x 18"	27.2	4	90.16
14938-014	8'3"/99" x 18"	30.9	4	104.38
14938-020	9'3"/111" x 18"	30.5	4	117.32
14938-026	10'3"/123" x 18"	32.5	4	131.60
14938-003	6'3"/75" x 24"	27.9	4	86.04
14938-009	7'3"/87" x 24"	32.2	4	100.50
14938-015	8'3"/99" x 24"	32.6	4	114.68
14938-021	9'3"/111" x 24"	34.6	4	128.96
14938-027	10'3"/123" x 24"	36.6	4	144.72
14938-010	7'3"/87" x 30"	31.5	4	107.36
14938-016	8'3"/99" x 30"	34.7	4	123.24
14938-022	9'3"/111" x 30"	37.9	4	136.76
14938-028	10'3"/123" x 30"	40.4	4	153.38



Catalog No.	Post Splicers	Wt. Each	Qty. Per Pack	List Price
09545-099	Post Splicer	.8	25	\$9.72
•09365-000	Splice/Bar	.5	20	7.98
•09366-000	Splice/Plate	.3	20	8.10
14934-000	B.P. Splice Kit	.7	40	13.94

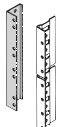

Post Splicer

Splice Plate & Bar

4 Splicer/Bar

Splice Kit

Catalog No.	Size	Wt. Each	Qty. Per Pack	List Price
Angle Post Closed Sides				
(height x depth)				
09608-098	3'3"/39" x 12"	7.7	4	\$25.26
09608-091	4'3"/51" x 12"	10.2	4	32.16
09608-084	5'3"/63" x 12"	12.2	4	39.56
09608-077	6'3"/75" x 12"	14.4	4	46.98
•09608-070	7'3"/87" x 12"	16.7	4	54.22
09608-063	8'3"/99" x 12"	18.2	4	61.74
09608-056	9'3"/111" x 12"	20.9	2	69.10
09608-049	10'3"/123" x 12"	22.7	2	80.30
09608-027	16'3"/195" x 12"	42.5	2	139.70
09608-097	3'3"/39" x 15"	8.6	4	\$28.00
09608-076	6'3"/75" x 15"	16.0	4	51.98
09608-069	7'3"/87" x 15"	18.6	4	59.20
09608-062	8'3"/99" x 15"	19.7	4	67.64
09608-055	9'3"/111" x 15"	22.5	2	75.72
09608-048	10'3"/123" x 15"	25.3	2	86.70



Closed Side Intermediate
An intermediate Closed Side is formed by attaching angle posts to the front and rear of angle post closed sides. NOTE: For each intermediate Closed Side desired, order one Angle Post Closed Side and two Angle Posts of the same height.

09608-096	3'3"/39" x 18"	9.5	4	\$31.16
09608-089	4'3"/51" x 18"	12.4	4	39.72
09608-082	5'3"/63" x 18"	15.1	4	48.50
•09608-075	6'3"/75" x 18"	17.5	4	56.64
•09608-068	7'3"/87" x 18"	20.6	4	65.74
•09608-061	8'3"/99" x 18"	23.1	4	74.26
09608-054	9'3"/111" x 18"	29.4	2	82.32
09608-047	10'3"/123" x 18"	33.9	2	91.74
09608-043	11'3"/135" x 18"	36.1	2	118.76
09608-041	12'3"/147" x 18"	39.0	2	126.62
09608-039	13'3"/159" x 18"	41.9	2	141.70
09608-037	14'3"/171" x 18"	45.3	2	151.12
09608-035	15'3"/183" x 18"	48.3	2	157.88
09608-025	16'3"/195" x 18"	50.6	2	182.12

09608-095	3'3"/39" x 24"	10.9	4	\$37.72
09608-088	4'3"/51" x 24"	14.4	4	47.06
09608-081	5'3"/63" x 24"	17.6	4	56.64
09608-074	6'3"/75" x 24"	20.8	4	66.68
•09608-067	7'3"/87" x 24"	24.2	4	74.66
•09608-060	8'3"/99" x 24"	29.0	2	86.18
09608-053	9'3"/111" x 24"	32.3	2	95.60
09608-046	10'3"/123" x 24"	36.3	2	106.44
09608-042	11'3"/135" x 24"	40.0	2	131.56
09608-040	12'3"/147" x 24"	42.8	2	146.94
09608-038	13'3"/159" x 24"	46.0	2	159.14
09608-036	14'3"/171" x 24"	49.8	2	170.40
09608-034	15'3"/183" x 24"	53.0	2	182.10
09608-024	16'3"/195" x 24"	56.1	2	194.28

09608-094	3'3"/39" x 30"	12.4	2	\$43.60
09608-087	4'3"/51" x 30"	15.2	2	71.14
09608-066	7'3"/87" x 30"	27.9	2	87.24
09608-059	8'3"/99" x 30"	31.1	2	98.10
09608-045	10'3"/123" x 30"	38.9	2	121.44
09608-072	6'3"/75" x 36"	27.3	2	\$86.22
09608-065	7'3"/87" x 36"	31.6	2	102.60
09608-058	8'3"/99" x 36"	36.1	2	110.82
09608-044	10'3"/123" x 36"	44.4	2	130.38
09608-022	16'3"/195" x 36"	74.7	2	211.88

Catalog No.	Foot Plates**	Wt. Each	Qty. Per Pack	List Price
•14952-000	Front	.4	80	\$3.64
•14953-000	Back-to-Back	.5	59	4.46
Shim Plates**				
14951-000	Front	.1	-	\$2.40
14949-000	Back to Back	.2	-	2.54
Post Accessories**				
05114-828	Post Foot Plate	.1	25	\$1.80
08702-829	Post Foot Angle	.2	25	3.92
04636-000	Shim Plate	.03	500	0.54

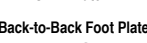
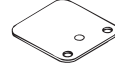

Front Foot Plate

Foot Plates**

Shim Plate

Back-to-Back Foot Plate

Shim Plate



**Available in #330 Aluminum only.

Special height Angle Posts and Closed Sides are available in 1-1/2" increments and special height Beaded Posts and Closed Sides are available in 3" increments. For these special height posts and closed sides - in quantities less than 200 pieces, use the next taller size list price plus a set-up charge of \$85.00 net per line item. For quantities greater than 200 pieces, please contact the factory for prices.

• InStock in #065 Industrial Gray

Steel Shelving Components

STEEL SHELVING

Catalog No.	Size	Wt. Each	Qty. Per Pack	List Price	
Post Covers					
 Type 1	13517-000	Type 1 3'3"/39"	1.4	4	\$33.56
	13517-001	Type 1 4'3"/51"	1.8	4	38.02
	13517-003	Type 1 6'3"/75"	2.7	4	42.50
	13517-004	Type 1 7'3"/87"	3.1	4	44.74
	13517-005	T1 R.H. 4'0"/48"	1.8	4	35.78
	13517-006	T1 L.H. 4'0"/48"	1.8	4	35.78
 Type 2	13518-000	Type 2 3'3"/39"	1.0	4	\$35.78
	13518-001	Type 2 4'3"/51"	1.3	4	38.02
	13518-003	Type 2 6'3"/75"	1.9	4	42.50
	13518-004	Type 2 7'3"/87"	2.2	4	44.74
	13518-005	Type 2 4'0"/48"	1.3	4	35.78
 Type 3	13519-000	Type 3 3'3"/39"	.8	4	\$33.56
	13519-001	Type 3 4'3"/51"	1.1	4	38.02
	13519-003	Type 3 6'3"/75"	1.7	4	42.50
	13519-004	Type 3 7'3"/87"	2.0	4	44.74
	13519-005	T3 R.H. 4'0"/48"	1.1	4	35.78
	13519-006	T3 L.H. 4'0"/48"	1.1	4	35.78

Shelving Backs (back clips included) (width x height)				
09551-099	24" x 7'3"/87"	15.1	5	\$49.22
09547-097	36" x 3'3"/39"	9.9	5	32.82
09548-097	36" x 4'3"/51"	13.1	5	43.28
09549-097	36" x 5'3"/63"	16.2	5	53.56
09550-097	36" x 6'3"/75"	19.3	5	63.68
•09551-097	36" x 7'3"/87"	22.5	5	71.56
14867-097	36" x 8'3"/99"	25.7	5	80.20
09547-096	42" x 3'3"/39"	11.4	5	38.62
09548-096	42" x 4'3"/51"	15.2	5	49.80
09549-096	42" x 5'3"/63"	18.8	5	62.06
09550-096	42" x 6'3"/75"	22.4	5	73.72
09551-096	42" x 7'3"/87"	26.2	5	85.82
14867-096	42" x 8'3"/99"	29.9	5	99.44
09547-095	48" x 3'3"/39"	13.0	5	44.02
09548-095	48" x 4'3"/51"	17.2	5	57.56
09549-095	48" x 5'3"/63"	21.4	5	67.00
09550-095	48" x 6'3"/75"	25.6	5	84.24
09551-095	48" x 7'3"/87"	29.8	5	97.92
14867-095	48" x 8'3"/99"	34.0	5	113.76

For other sizes, please contact factory for price and availability.

Extra Back Clips				
05088-824		.1	-	\$0.62

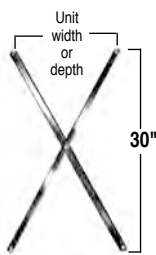
Catalog No.	Size	Wt. Each	Qty. Per Pack	List Price	
Cross Braces (price per pair)					
 Unit width or depth 30"	13826-000	Back - 24"	2.0	12 pr.	\$9.18
	•13828-000	Back - 36"	2.4	12 pr.	10.12
	•05017-815	Back - 42"	2.6	12 pr.	10.56
	•05165-815	Back - 48"	2.8	12 pr.	11.26
	•05019-815	Side - 12"	1.4	12 pr.	8.34
	•05583-815	Side - 15"	1.6	12 pr.	8.42
	•05020-815	Side - 18"	1.8	12 pr.	8.66
	•13829-000	Side - 24"	2.0	12 pr.	9.04
	•13830-000	Side - 30"	2.2	12 pr.	9.56
	10445-000	Side - 32"	2.2	12 pr.	9.80
	•13831-000	Side - 36"	2.4	12 pr.	10.02

Face Braces (price per pair)				
10462-000	Angle Post	1.4	20 pr.	\$8.32
10463-000	Beaded Post	1.6	20 pr.	12.34

BOX EDGE PLUS® Shelves (4 shelf brackets included)				
PLUS 1	(width x depth)	Pack / Pallet		
10437-000	24" x 12"	4.3	10 / 360	\$19.62
•10437-001	36" x 12"	6.2	10 / 200	19.62
•10437-003	48" x 12"	8.3	10 / 180	25.54
10446-001	36" x 15"	7.3	10 / 120	25.06
10439-000	24" x 18"	5.6	10 / 240	25.88
•10439-001	36" x 18"	8.2	10 / 120	25.88
10439-002	42" x 18"	9.4	10 / 180	*
•10439-003	48" x 18"	11.0	6 / 90	34.90
10441-000	24" x 24"	7.0	10 / 120	32.66
•10441-001	36" x 24"	10.2	10 / 80	32.66
•10441-003	48" x 24"	13.7	6 / 60	43.80
PLUS 2				
10428-001	36" x 12"	7.4	10 / 120	\$22.32
10428-002	42" x 12"	8.6	10 / 180	25.52
•10428-003	48" x 12"	9.7	10 / 180	27.98
10429-001	36" x 15"	8.6	10 / 120	28.46
•10429-002	42" x 15"	10.0	10 / 120	30.26
10429-003	48" x 15"	11.3	6 / 120	33.10
•10430-001	36" x 18"	9.7	10 / 120	29.30
10430-002	42" x 18"	11.4	10 / 120	35.18
•10430-003	48" x 18"	12.9	6 / 120	38.62
•10432-001	36" x 24"	12.2	10 / 120	36.28
10432-002	42" x 24"	14.2	6 / 60	41.98
•10432-003	48" x 24"	16.1	6 / 60	48.72
10434-001	36" x 30"	14.6	6 / 60	44.94
•10434-002	42" x 30"	16.9	6 / 60	51.44
10434-003	48" x 30"	19.2	6 / 60	58.50
10435-002	42" x 32"	17.0	6 / 60	55.54
•10436-001	36" x 36"	17.0	6 / 60	54.88
10436-002	42" x 36"	19.7	6 / 60	60.16
10436-003	48" x 36"	22.4	6 / 60	67.98
PLUS 3				
10419-001	36" x 12"	9.9	10 / 120	\$28.76
10419-002	42" x 12"	11.5	10 / 180	33.68
10419-003	48" x 12"	13.0	10 / 180	36.76
10420-001	36" x 15"	11.5	10 / 120	35.04
10420-002	42" x 15"	13.3	10 / 120	38.44
10420-003	48" x 15"	15.1	6 / 120	42.02
10421-001	36" x 18"	13.1	10 / 120	35.86
10421-002	42" x 18"	15.2	10 / 120	42.32
10421-003	48" x 18"	17.3	6 / 120	47.68
10423-001	36" x 24"	16.3	10 / 120	43.08
10423-002	42" x 24"	18.9	6 / 60	50.40
10423-003	48" x 24"	21.5	6 / 60	57.74
10425-001	36" x 30"	19.6	6 / 60	52.04
10425-002	42" x 30"	22.6	6 / 60	60.36
10425-003	48" x 30"	25.7	6 / 60	68.04
10426-002	42" x 32"	23.9	6 / 60	64.62
10427-001	36" x 36"	22.8	6 / 60	60.78
10427-002	42" x 36"	26.3	6 / 60	69.50
10427-003	48" x 36"	30.0	6 / 60	77.84
09531-099	Extra Brackets	.07	500	.78

Please Note
All shelves punched on 2" centers for shelf dividers, except for 42" x 30" and 42" x 32" which have no divider holes.

Please Note
To order palletized quantity, add a "P" to the part number after the color number.
Example:
10437-001-065 changes to 10437-001-065P.

*Contact factory for price and availability.

• InStock in #065 Industrial Gray

Steel Shelving Components

STEEL SHELVING

Catalog No.	Size	Wt. Each	Qty. Per Pack	List Price
Shelf Saddles				
09610-097	36" w	2.7	12	\$10.54
09610-096	42" w	3.1	12	11.06
09610-095	48" w	3.6	12	12.12
Shelf Side Supports (price per pair)				
09555-098	12" d	1.2	12 pr.	\$9.48
09555-096	18" d	1.9	12 pr.	10.78
09555-095	24" d	2.6	12 pr.	13.76
09555-094	30" d	3.3	12 pr.	15.78
09555-093	36" d	3.9	12 pr.	16.60
Base Strips - Angle Posts				
09554-099	24" w	.6	24	\$6.16
•09554-097	36" w	.9	24	6.16
09554-096	42" w	1.0	24	6.48
•09554-095	48" w	1.2	24	\$6.94
Base Strips - Beaded Posts				
09614-097	36" w	1.0	24	\$8.84
09614-096	42" w	1.2	24	9.36
09614-095	48" w	1.3	24	\$9.66
Label Holders				
09556-099	24" w	.1	100	\$3.10
•09556-097	36" w	.2	100	3.10
09556-096	42" w	.2	100	3.30
•09556-095	48" w	.3	100	3.38
10460-000	4' Magnetic	.8	100	12.32
Sliding Shelf Dividers (height x depth)				
14745-000	4-1/2" x 12"	0.8	36	\$8.50
14745-001	4-1/2" x 15"	1.0	36	*
14745-002	4-1/2" x 18"	1.2	36	9.84
14745-003	4-1/2" x 24"	1.6	36	10.30
14745-004	6" x 12"	0.8	32	8.74
14745-005	6" x 15"	1.1	32	*
14745-006	6" x 18"	1.3	32	10.08
14745-007	6" x 24"	1.7	32	*
Angle Shelf Dividers* (height x depth)				
05490-842	1-1/2" x 12"	.3	25	*
05493-842	3" x 12"	.4	25	*
05492-842	1-1/2" x 18"	.4	25	*
05495-842	3" x 18"	.6	25	*
Boltless Hang Bars (width x depth)				
10140-000	24" x 18"	2.3	6	\$53.40
10140-004	24" x 24"	3.0	6	58.34
10140-001	36" x 18"	2.9	6	53.40
10140-005	36" x 24"	3.6	6	58.34
10140-002	48" x 18"	3.3	6	56.42
10140-006	48" x 24"	4.0	6	60.86

Field cut rod for 42" width.





Catalog No.	Size	Wt. Each	Qty. Per Pack	List Price
Shelf Dividers Fixed (height x depth)				
05599-807	6" x 12"	.7	60	\$4.74
05606-807	9" x 12"	1.0	40	6.24
05613-807	12" x 12"	1.4	32	7.06
05620-807	15" x 12"	1.7	20	10.30
05627-807	18" x 12"	2.0	20	13.28
05600-807	6" x 15"	.8	60	*
05607-807	9" x 15"	1.5	40	*
05614-807	12" x 15"	1.8	32	10.34
05621-807	15" x 15"	2.0	20	15.14
05628-807	18" x 15"	2.7	20	*
05601-807	6" x 18"	1.1	48	5.52
05608-807	9" x 18"	1.6	32	6.80
05615-807	12" x 18"	2.1	20	8.84
05622-807	15" x 18"	2.6	16	12.56
14374-000	16-1/2" x 18"	2.8	16	13.76
05629-807	18" x 18"	3.0	16	15.18
05643-807	24" x 18"	4.3	10	22.34
05602-807	6" x 24"	1.4	48	8.84
05609-807	9" x 24"	2.1	32	*
05616-807	12" x 24"	2.7	20	13.42
05623-807	15" x 24"	3.4	16	16.28
05630-807	18" x 24"	4.0	16	18.82
05637-807	21" x 24"	4.5	10	22.80
05644-807	24" x 24"	5.2	10	24.02
05604-807	6" x 36"	2.2	30	*
05611-807	9" x 36"	3.5	20	15.02
05618-807	12" x 36"	4.3	20	19.02
Shelf Divider Supports (price per pair)				
05595-827	36"	1.9	24	\$15.08
Divider and Label Holder Fastener				
47955-00	Push-in Rivet			\$.16
Long Parts Frame				
09576-099	36" x 12"	5.0	10	\$38.82
06238-860	Rod - 12"	.3	50	2.26
09576-098	36" x 18"	5.6	10	\$41.22
06239-860	Rod - 18"	.4	50	2.72
09576-097	36" x 24"	6.1	10	\$44.02
06240-860	Rod - 24"	.3	50	3.06
Shelf Boxes (partitions not included) (width x depth)				
05339-808	5" x 11"	2.6	30	\$18.82
05345-808	8" x 11"	3.3	20	25.66
05351-808	11" x 11"	4.1	14	27.38
05325-808	5" x 17"	3.7	20	21.84
05347-808	8" x 17"	4.6	12	28.18
05353-808	11" x 17"	5.5	10	31.38
05342-808	5" x 23"	4.6	15	30.00
05349-808	8" x 23"	5.8	10	31.38
05355-808	11" x 23"	6.9	7	40.88
Box Partitions (available in #445 White only)				
05476-810	5"	.2	200	\$1.56
05477-810	8"	.3	100	2.14
05478-810	11"	.4	100	2.54
09559-099	Box Guides	.19	12 pr.	7.40
Shelf Lock				
08703-823-330				\$2.52

*Contact factory for price and availability

• InStock in #065 Industrial Gray

Steel Shelving Components

STEEL SHELVING

Catalog No.	Size	Wt. Each	Qty. Per Pack	List Price
Bin Fronts - Angle Posts				
 05698-819	36" x 1-1/2"	2.2	25	\$10.18
05701-819	42" x 1-1/2"	2.6	25	16.00
05704-819	48" x 1-1/2"	2.7	25	16.28
09557-099	24" x 3"	2.0	25	*
09557-097	36" x 3"	3.2	25	11.52
09557-096	42" x 3"	3.8	25	15.88
09557-095	48" x 3"	4.1	25	16.26
09558-097	36" x 6"	4.5	12	20.16
09558-096	42" x 6"	5.3	12	*
09558-095	48" x 6"	6.0	12	32.44
Bin Front Clips - Angle Posts (available in #330 Aluminum only)				
 05707-835	1-1/2"	.1	100	\$.88
05708-836	3" and 6"	.1	50	1.78
Bin Fronts - Beaded Posts				
 09615-097	36" x 1-1/2"	2.5	24	*
09616-097	36" x 3"	3.2	12	*
Counter Tops				
				
09570-099	36" x 18"	18.6	2	\$88.92
09570-098	42" x 18"	27.3	2	103.36
09569-099	36" x 24"	25.5	2	105.86
09569-098	42" x 24"	31.5	2	123.34
09569-097	36" x 30"	32.3	2	131.94
09569-096	42" x 30"	38.3	2	153.56
Ledge Tops				
09565-092	36" x 12"	13.1	2	\$59.34
09565-091	42" x 12"	14.9	2	68.98
09565-090	48" x 12"	16.9	2	78.58
09565-082	36" x 18"	17.4	2	88.06
09565-081	42" x 18"	19.6	2	102.38
09565-080	48" x 18"	22.0	2	117.00
Counter Backs				
09571-097	36" x 3'3"	19.3	4	\$66.46
09571-096	42" x 3'3"	22.6	4	82.02
Spray Paint				
14219-000	12 oz. can		12	\$32.96
Specify any standard color.				

Catalog No.	Size	Wt. Each	Qty. Per Pack	List Price
Framed Swing Doors - Angle Post (price per pair) (width x height)				
13402-001	36" x 3'3"/39"	29.6	1 pr.	\$289.72
13404-001	36" x 4'0"/48"	36.3	1 pr.	336.12
13402-005	36" x 4'3"/51"	37.0	1 pr.	337.08
•13402-013	36" x 6'3"/75"	54.4	1 pr.	366.50
•13402-017	36" x 7'3"/87"	61.0	1 pr.	372.48
13402-002	42" x 3'3"/39"	40.3	1 pr.	350.16
13402-014	42" x 6'3"/75"	56.0	1 pr.	468.96
13402-018	42" x 7'3"/87"	68.5	1 pr.	468.96
13402-003	48" x 3'3"/39"	35.7	1 pr.	491.92
13402-015	48" x 6'3"/75"	74.4	1 pr.	469.30
13402-019	48" x 7'3"/87"	87.5	1 pr.	471.40
Sliding Doors - Angle Post (price per pair) (width x height)				
09626-099	72" x 3'3"/39"	64.8	1 pr.	\$602.16
09627-099	72" x 7'3"/87"	112.8	1 pr.	793.28

Please Note
Doors Only.
Units must be ordered separately.

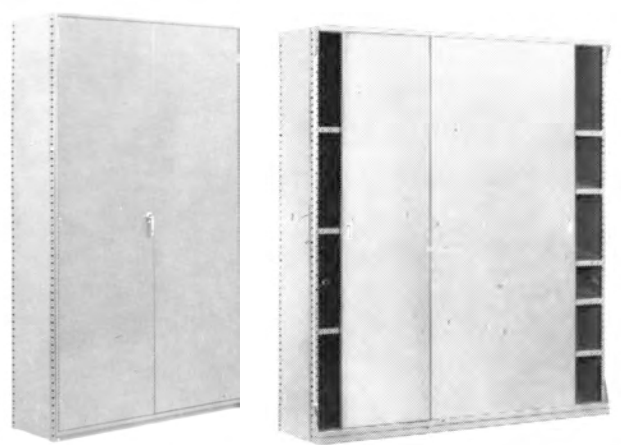

*Contact factory for price and availability

Steel Shelving Components

Specifications

STEEL SHELVING

Catalog No.	Size	Wt. Each	List Price
High-Rise Posts			
14917-000	7'3"/87"	14.2	\$38.82
14917-001	8'3"/99"	16.2	42.56
14917-002	9'3"/111"	18.2	46.86
14917-003	10'3"/123"	20.1	57.22
14917-004	12'3"/147"	24.1	67.96
14917-008	13'3"/159"	29.6	72.14
14917-005	15'3"/183"	29.9	83.90
14917-006	16'3"/195"	31.9	89.16
Side Panels - High-Rise Post			
14918-000	4'3"/51" x 12"	5.1	\$16.34
14918-001	4'3"/51" x 15"	6.4	18.34
14918-002	4'3"/51" x 18"	8.0	22.32
14918-003	4'3"/51" x 24"	10.2	28.16
14918-004	4'3"/51" x 30"	12.8	37.72
14918-005	4'3"/51" x 32"	14.0	39.66
14919-000	5'3"/63" x 12"	5.8	\$20.14
14919-001	5'3"/63" x 12"	7.3	22.96
14919-002	5'3"/63" x 18"	9.1	27.82
14919-003	5'3"/63" x 24"	11.6	36.76
14919-004	5'3"/63" x 30"	14.5	47.06
14919-005	5'3"/63" x 32"	15.4	49.52
14920-000	7'3"/87" x 12"	7.8	\$28.18
14920-001	7'3"/87" x 15"	9.8	32.16
14920-002	7'3"/87" x 18"	11.8	38.90
14920-003	7'3"/87" x 24"	15.1	49.22
14920-004	7'3"/87" x 30"	17.1	66.06
14920-005	7'3"/87" x 32"	18.8	69.24
14921-000	8'3"/99" x 12"	8.8	\$32.26
14921-001	8'3"/99" x 15"	11.0	36.70
14921-002	8'3"/99" x 18"	13.1	44.36
14921-003	8'3"/99" x 24"	17.6	56.06
14921-004	8'3"/99" x 30"	19.6	75.36
14921-005	8'3"/99" x 32"	21.4	79.08
Splicer Kit - High-Rise Post			
14928-000		1.3	\$15.66
Back Panels - High-Rise Post (#445 White)			
14922-000	4'3"/51" x 24"	10.2	\$31.44
14922-001	4'3"/51" x 36"	13.1	45.34
14922-002	4'3"/51" x 42"	15.2	50.72
14922-003	4'3"/51" x 48"	17.2	55.90
14923-000	5'3"/63" x 24"	11.6	\$39.38
14923-001	5'3"/63" x 36"	16.2	56.50
14923-002	5'3"/63" x 42"	18.8	63.40
14923-003	5'3"/63" x 48"	21.4	69.80
14924-000	7'3"/87" x 24"	15.1	\$54.96
14924-001	7'3"/87" x 36"	22.5	79.12
14924-002	7'3"/87" x 42"	26.2	88.60
14924-003	7'3"/87" x 48"	29.8	97.54
14925-000	8'3"/99" x 24"	17.6	\$62.78
14925-001	8'3"/99" x 36"	25.7	90.34
14925-002	8'3"/99" x 42"	29.9	101.26
14925-003	8'3"/99" x 48"	34.0	111.68
Back Braces - High-Rise Post (price per pair)			
14926-000	24"	2.0	\$10.00
14926-001	36"	2.4	10.98
14926-002	42"	2.6	11.50
14926-003	48"	2.8	12.28
Back Attachment Kit - High-Rise*			
14927-001		-	\$5.34
Mezzanine Bracket - High-Rise Post			
14941-000		.8	\$9.66
Catwalk Beams - High-Rise Post			
10134-000	30" x 2-3/4" h	5.1	\$26.18
10134-001	36" x 2-3/4" h	5.8	28.36
10134-002	42" x 2-3/4" h	6.5	29.88
10134-003	48" x 2-3/4" h	7.3	36.90
Captive Clip - High-Rise			
14940-000			**

Basic Data

Widths

Nominal unit width: 24", 36", 42" or 48"
 Actual beaded post unit width is the nominal width plus 1" ^{+1/16"}_{-0"}
 Actual angle post unit width is the nominal width ^{+1/16"}_{-0"}

Depths

Nominal depth: 12", 15", 18", 24", 30", 32" or 36"
 Actual beaded post unit depth is the nominal depth plus 15/32" ^{+1/32"}_{-0"}
 with beaded post in front and angle post in back
 Actual angle post unit depth is the nominal depth ^{+1/32"}_{-0"}

Heights

Nominal height: One foot increments from 3'3"/39" to 16'3"/195"
 Actual height is the nominal height minus 1/4" $\pm 1/16"$
 NOTE: Unit anchoring is recommended when the height to depth ratio exceeds 4.
 EXAMPLE: 7'3"/87" high x 18" deep unit has a height to depth ratio of 4.873 and should be anchored to a firm restraint such as a floor or wall

Length of Run

Actual length of beaded post shelving run is nominal unit width ^{+1/16"}_{-0"} per unit plus 1/2" for each row end.
 Actual length of angle post shelving run is nominal unit width ^{+1/16"}_{-0"} per unit

Clear Shelf Opening

Actual clear opening between beaded posts is the nominal width minus 1"
 Actual clear opening between angle posts is the nominal width minus 2"
 Vertical clearance between shelves is equal to center-to-center shelf spacing minus 1-7/32"

Vertical Adjustment

All shelves are adjustable on 1-1/2" centers

BOX EDGE PLUS® Shelf Capacities

	BOX EDGE PLUS 1	BOX EDGE PLUS 2	BOX EDGE PLUS 3
SIZE	CAPACITY		
24" x 12"	550 lbs.		
36" x 12"	550 lbs.	725 lbs.	1000 lbs.
42" x 12"		550 lbs.	925 lbs.
48" x 12"	375 lbs.	450 lbs.	725 lbs.
36" x 15"	550 lbs.	725 lbs.	1000 lbs.
42" x 15"		550 lbs.	925 lbs.
48" x 15"		450 lbs.	725 lbs.
24" x 18"	550 lbs.		
36" x 18"	550 lbs.	725 lbs.	1100 lbs.
42" x 18"		550 lbs.	925 lbs.
48" x 18"	375 lbs.	450 lbs.	725 lbs.
24" x 24"	550 lbs.		
36" x 24"	550 lbs.	725 lbs.	1100 lbs.
42" x 24"		550 lbs.	925 lbs.
48" x 24"	375 lbs.	450 lbs.	725 lbs.
36" x 30"		550 lbs.	825 lbs.
42" x 30"	275 lbs.	550 lbs.	725 lbs.
48" x 30"		450 lbs.	700 lbs.
42" x 32"		600 lbs.	925 lbs.
36" x 36"		375 lbs.	550 lbs.
42" x 36"		425 lbs.	550 lbs.
48" x 36"		425 lbs.	650 lbs.

*4 brackets per kit - one kit needed per pair of braces.
 Locate brackets on 30" centers for backs.

**Contact factory for price and availability.

Sway Bracing Recommendations

For Units 99" and Less in Height

		Single Row						
No. Units	8	7	6	5	4	3	2	1
No. Braces	10	9	8	7	6	5	4	3

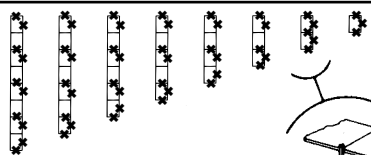

Fig. 1

		Double Row						
No. Units	16	14	12	10	8	6	4	2
No. Braces	16	14	13	11	10	8	6	3

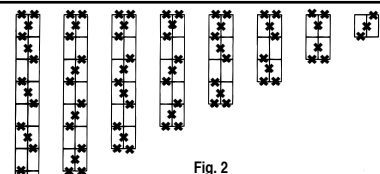
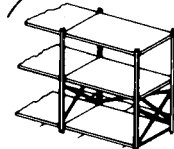

Fig. 2



NOTE:
FOR CRITICAL SHELF LOCATIONS, MINOR CHANGES TO THESE RECOMMENDATIONS ARE ACCEPTABLE.

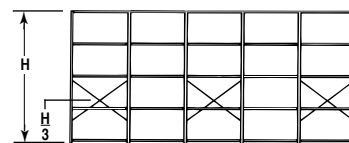

Fig. 3
Back Brace

Light Loading

Both single and double rows may use sway braces as in Figures 1 and 2. The end and back of the first and last section of each row always contains a sway brace. Every other intermediate and every other back should contain a sway brace. The height location of the sway brace is determined as in Figure 3, where the center line of the cross is "height divided by 3" up from the bottom.

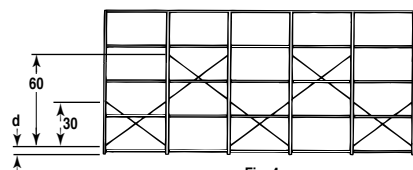

Fig. 4
Back Brace

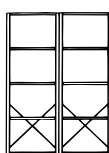

Fig. 4A
Side Brace

Standard Loading

For rigidity in standard duty applications, a pair of sway braces should be put in every opening at the heights illustrated in Figure 4. Each open end should be braced as illustrated in Figure 4A.

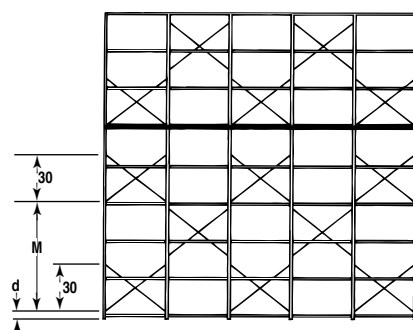

Fig. 5
Back Brace

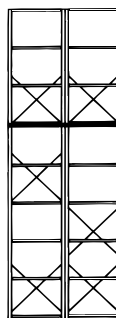

Fig. 5A
Side Brace

Connection point as close as possible to mezzanine level- may be either above or below level.

M = maximum distance possible - up to and including 30"

d = minimum reasonable distance (e.g. 4.5" - 6.0")

Multi-Level Application

For rigidity in mezzanine applications, two sway braces should be put in every other opening at the heights illustrated in Figure 5. The intervening openings should be braced with one pair of sway braces as shown. The term "d" equals the distance for mounting the sway braces to the post from the floor. Bolt the front of the center shelf and the front of the top shelf and the base strip in place. The open ends should be braced as illustrated in Figure 5A.

For Units Over 99" High

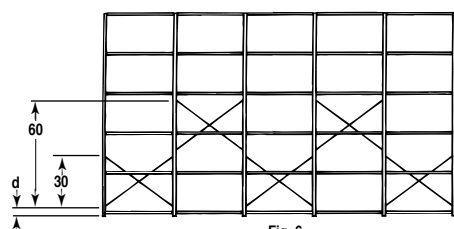

Fig. 6
Back Brace

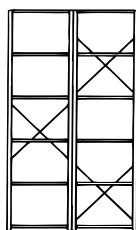

Fig. 6A
Side Brace

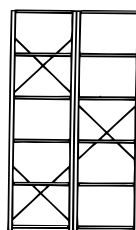

Fig. 6B
Side Brace

Light Loading

For rigidity, Borroughs recommends that one pair of sway braces be installed in each open end and open back. Sway brace height is as shown in Figure 6. Figure 6A and 6B are an end and an intermediate, respectively. The bracing patterns are opposite each other and should alternate from one end of a row down to the other end. Pre-assembly of the two uprights is identical.

NOTE:
FOR CRITICAL SHELF LOCATIONS, MINOR CHANGES TO THESE RECOMMENDATIONS ARE ACCEPTABLE.

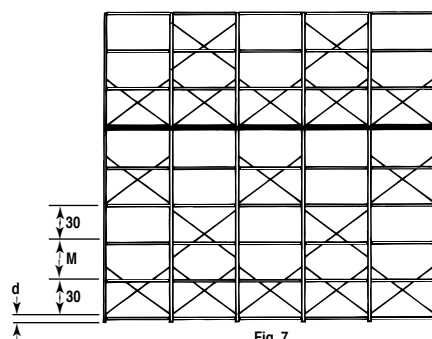

Fig. 7
Back Brace

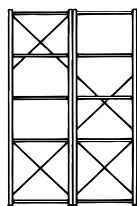

Fig. 7A
Side Brace

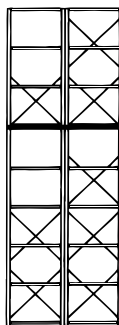

Fig. 7B
Side Brace

Connection point as close as possible to mezzanine level- may be either above or below level.

M = maximum distance possible - up to and including 30"

d = minimum reasonable distance (e.g. 4.5" - 6.0")

Standard Loading and Multi-Level

For rigidity, Borroughs recommends that sway braces be used in open backs as illustrated in Figure 7. Sway brace height is as shown in Figure 7. Bolt the front of the center shelf and the front of the top shelf and the base strip in place. Sway bracing for the ends of sections should be installed as shown in Figure 7A for heavy-duty and Figure 7B for multi-level applications.

Multi-Level Steel Shelving

STEEL SHELVING

Catalog No.	Size	Wt. Each	Qty. Per Pack	List Price
Post Splicers				
09545-099	Post Splicer	.8	25	\$9.72
•09365-000	Splice/Bar	.8	25	7.98
•09366-000	Splice/Plate	.8	25	8.10
14934-000	B.P. Splice Kit	.8	25	13.94

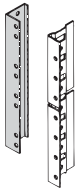

Post Splicer



Splice Plate & Bar



4 Splicer Bars



Splice Kit

Catalog No.	Size	Wt. Each	Qty. Per Pack	List Price
Mezzanine Beams				
14064-000	36" x 2-1/2" h	5.3	6	\$23.20
14064-001	42" x 2-1/2" h	6.0	6	28.18
14064-002	48" x 2-1/2" h	6.9	6	31.50
Mezzanine Bracket - Angle Post				
14065-000		.3	30	\$5.22
Mezzanine Bracket - Beaded Post				
14941-000		.8	9	\$9.66

Catalog No.	Size	Wt. Each	Qty. Per Pack	List Price
Catwalk Beams - Angle Post				
10135-000	30" x 2-3/4" h	5.0	8	\$24.90
10135-001	36" x 2-3/4" h	5.6	8	27.04
10135-002	42" x 2-3/4" h	6.3	8	28.46
10135-003	48" x 2-3/4" h	7.0	8	35.18
Catwalk Beams - Beaded Post				
10134-000	30" x 2-3/4" h	5.1	8	\$26.18
10134-001	36" x 2-3/4" h	5.8	8	28.36
10134-002	42" x 2-3/4" h	6.5	8	29.88
10134-003	48" x 2-3/4" h	7.3	8	36.90

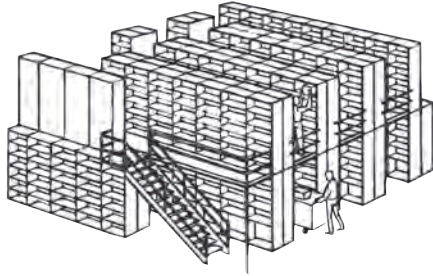
Catalog No.	Size	List Price
		
Type I Model # MEZ-1	27'4" x 29'0"	Contact factory for price and availability

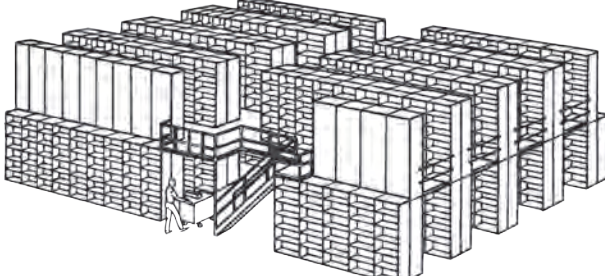
		
Type II Model # MEZ-2	62'0" x 27'4"	Contact factory for price and availability

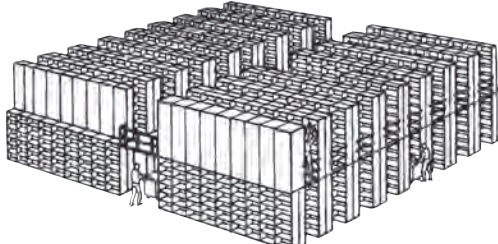
		
Type III Model # MEZ-3	62'0" x 51'8"	Contact factory for price and availability

Seismic Risk Map of the United States

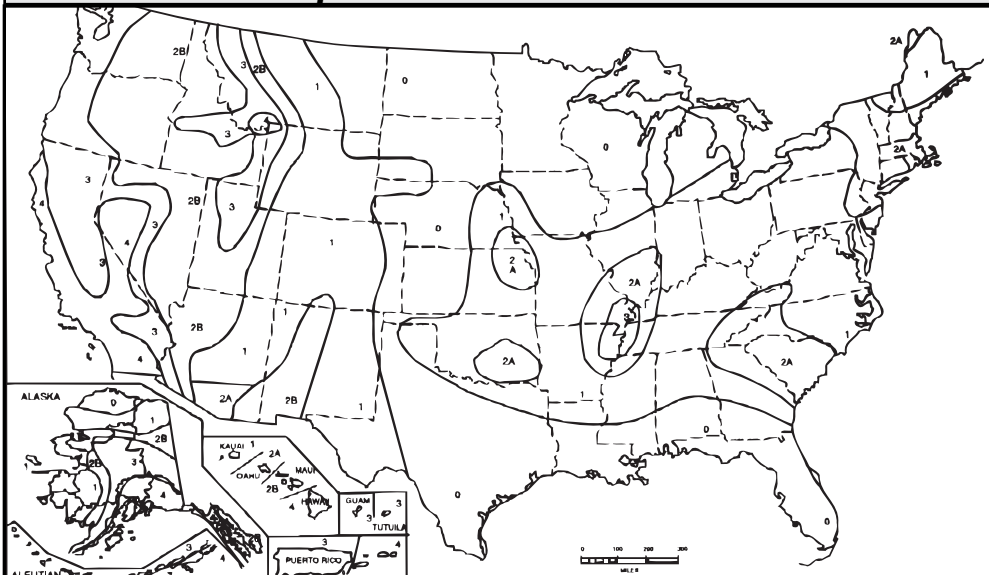

All areas of the United States have been zoned seismically. Each zone indicates the anticipated intensity or severity of a seismic occurrence within that region. Zones range from 0 (least likely) to 4 (most likely) to experience damage.

NOTE: Special care should be taken when specifying any system in a highly seismic area.

Portions of this publication reproduce figures/maps from the 1997 Uniform Building Code, Volume 2, International Code Council, Inc., Falls Church, Virginia. Reproduced with permission. All rights reserved.



ICBO and/or ICC and Boroughs assume no responsibility for the accuracy or the completion of summaries provided herein.

Borroughs Cap System

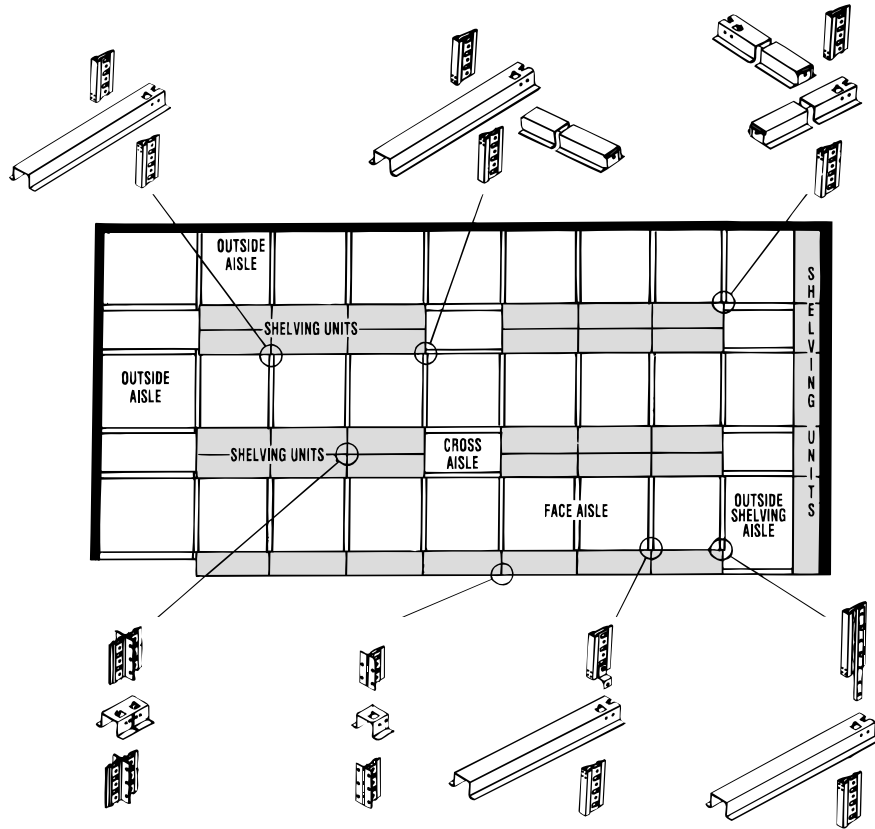
STEEL SHELVING

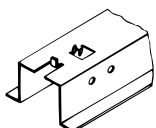
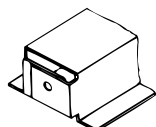
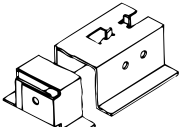
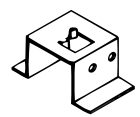
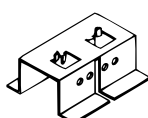

Catalog No.	Size	Wt. Each	Qty. Per Pack	List Price
Face Aisle Cap Beam				
	10409-000	*36" x 1-7/8" h	6.7 18	\$27.96
	10409-002	*42" x 1-7/8" h	7.8 18	31.66
	10409-003	*48" x 1-7/8" h	8.6 18	33.82
*Using face aisle cap beams with angle posts adds 1" to aisle width.				
Cross Aisle Cap Beam				
	10408-002	36" x 1-7/8" h	5.7 18	\$29.20
	10408-000	42" x 1-7/8" h	6.6 18	32.18
	10408-001	48" x 1-7/8" h	8.6 18	34.30
Outside Aisle Cap Beam				
	10457-000	36" x 1-7/8" h	6.3 18	\$30.60
	10457-001	42" x 1-7/8" h	7.2 18	33.96
	10457-002	48" x 1-7/8" h	8.1 18	36.16
Single Face Back Cap				
	10418-000	1-7/8" h	.4 24	\$9.22
Back to Back Cap				
	10417-000	1-7/8" h	.7 24	\$12.92

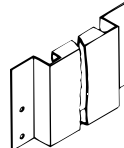
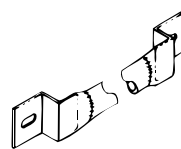
Catalog No.	Size	Wt. Each	Qty. Per Pack	List Price
Single Face Attachment Bracket				
	10455-000	-	.1 25	\$5.30
Row End Corner Splice Channel				
	10415-000	-	.4 25	\$5.94
NOTE: For High-Rise or Beaded Post Mezzanines Only.				
Row End Kick Plate				
	10407-000	36"	6.4 6	\$35.64
	10407-001	42"	7.3 6	47.42
	10407-002	48"	8.3 6	59.04
NOTE: For High-Rise or Beaded Post Mezzanines Only.				
Row End Hand Rail				
	10413-000	36"	2.0 12	\$35.42
	10413-001	42"	2.3 12	47.04
	10413-002	48"	2.7 12	58.62

NOTE: The Cap System is NOT recommended for use in Seismic Zones 3 & 4

General Information

Smooth Ball Bearing
Slide Suspension

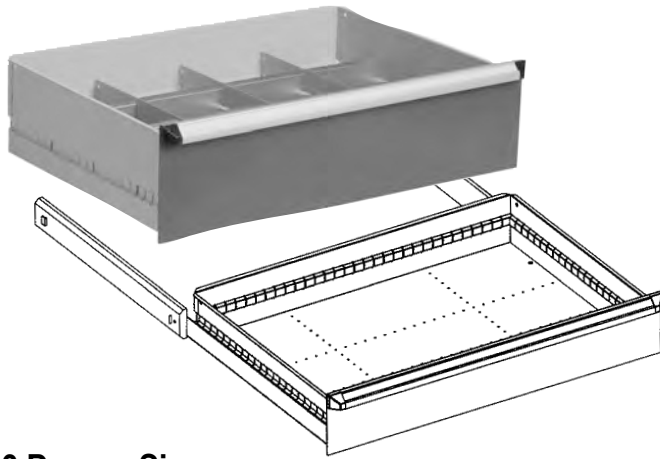

Borroughs has drawers for the four most frequently used shelving sizes: 36" wide x 18" deep, 36" wide x 24" deep, 48" wide x 18" deep and 48" wide x 24" deep. Each of these four sizes also has four different height choices: 3", 4-1/2", 6" and 9" high...And, drawers are interchangeable with other drawers in shelving units of the same size. Borroughs' drawers arrange and rearrange to use your space, exactly the way you need it. They are designed to contribute to the efficiency of your storage system as your operation grows and changes. Drawers are rated for up to 400 lb. capacity with an evenly distributed load. Drawers feature a suspension system that allows full extension to access entire contents of drawer.



HD DRAWERS

16 Drawer Sizes

Drawer Sizes	Body Height	Useable Height	36" x 18"	36" x 24"	48" x 18"	48" x 24"
3"	2-1/4"	2-1/2"				
4-1/2"	3-1/8"	4"				
6"	4-5/8"	5-1/2"				
9"	7-5/8"	8-1/2"				

Partitions

Partitions and dividers combine for an almost endless variety of storage spaces to match stored items.

Slotted steel partitions create major drawer interior storage spaces. Partitions slide into slots on drawer walls to span the full width or depth of drawers...And, allow the addition of dividers to further sub-divide the drawer's interior.

Partitions are available in 18" and 24" depths; 36" and 48" widths and 3", 4-1/2" and 6" heights. All partitions are painted #161 Mist Gray.



Dividers

Galvanized steel dividers sub-divide the storage spaces between partitions or partitions and drawer walls. Dividers simply drop into slots in partitions and drawer walls making storage space adjustments quick and easy.



Slots are manufactured in partitions and drawer walls on 1" nominal centers. Divider widths are measured by the number of drawer wall slots the divider spans (i.e. a 3s divider will span 3 slots). Dividers are available in heights to match partitions (3", 4-1/2" and 6") and in eleven widths (3 slots through 13 slots). The 36" wide drawer has 31 slots allowing for up to 10 3s storage spaces. The 48" wide drawer has 43 slots, allowing for up to 14 3s storage spaces.

HD Drawer Dividers

Dimensional Conversion Chart

Catalog Size	Actual Width	x 3" high	x 4-1/2" high	x 6" high
		Actual Height	Actual Height	Actual Height
3 slots	2.828"	2.053"	2.921"	4.420"
4 slots	3.828"	2.053"	2.921"	4.420"
5 slots	4.828"	2.053"	2.921"	4.420"
6 slots	5.828"	2.053"	2.921"	4.420"
7 slots	6.828"	2.053"	2.921"	4.420"
8 slots	7.828"	2.053"	2.921"	4.420"
9 slots	8.828"	2.053"	2.921"	4.420"
10 slots	9.828"	2.053"	2.921"	4.420"
11 slots	10.828"	2.053"	2.921"	4.420"
12 slots	11.828"	2.053"	2.921"	4.420"
13 slots	12.828"	2.053"	2.921"	4.420"

Preconfigured Drawers

Borroughs offers a large number of standard preconfigured drawer interiors frequently ordered for small parts storage...And, for simplicity, these Borroughs' drawers and interiors can be ordered as a complete, outfitted assembly using only one part number.

This, without any surcharge, provides the drawer, including the suspension and handle/label holder, factory installed partitions with essential dividers packaged in one carton. This makes ordering quick and easy...and saves installation time, too!

Example:

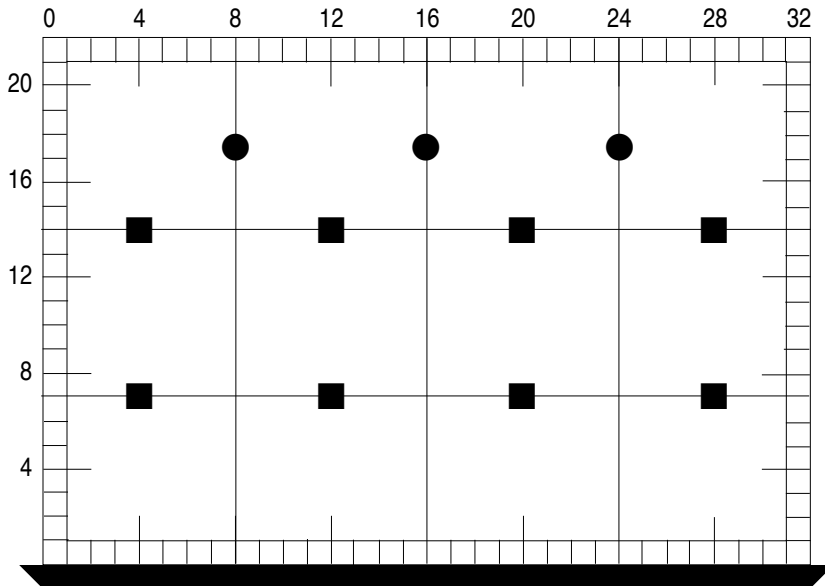
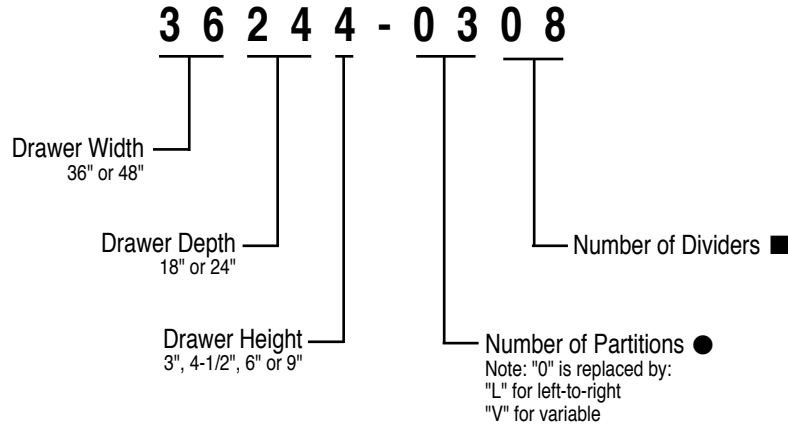

Drawer fronts are painted #065 Industrial Gray, #445 White, #C386 Red, #B504 Blue, #F604 Pebble, #161 Mist Gray or #040 Black

- Drawer interiors are painted #161 Mist Gray
- Drawers include full-width aluminum handle/label holder, end caps, paper label and clear plastic label cover
- Drawers packed one per box
- Drawer dividers are galvanized steel
- Drawer partitions are painted #161 Mist Gray and installed in drawer
- Drawer dividers are taped together and packed in drawer
- 9" high drawers use 6" high partitions and dividers
- Drawer slides are packed separately

HD DRAWERS

Preconfigured 36" x 18" Drawers

HD DRAWERS

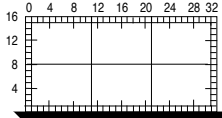
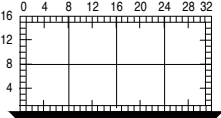
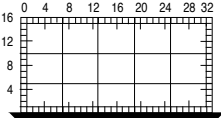
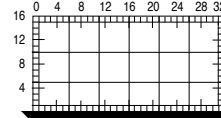
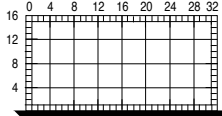
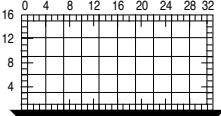
Catalog No.	List Price	Wt.	Catalog No.	List Price	Wt.	Catalog No.	List Price	Wt.	Catalog No.	List Price	Wt.
<div style="display: flex; justify-content: space-between;"> <div style="width: 24%;">  <p>6 Compartments (4) 10" x 7-11/16" (2) 9-1/8" x 7-11/16"</p> </div> <div style="width: 24%;">  <p>8 Compartments (8) 7-1/8" x 7-11/16"</p> </div> <div style="width: 24%;">  <p>15 Compartments (2) 6-1/8" x 5-3/4" (4) 6-1/8" x 4-13/16" (3) 5-1/8" x 5-3/4" (6) 5-1/8" x 4-13/16"</p> </div> <div style="width: 24%;">  <p>18 Compartments (2) 5-1/8" x 5-3/4" (4) 5-1/8" x 4-13/16" (4) 4-3/16" x 5-3/4" (8) 4-3/16" x 4-13/16"</p> </div> </div>											
36183-0203	\$219.16	36.7	36183-0304	\$230.38	37.9	36183-0410	\$249.62	39.8	36183-0512	\$261.90	40.9
36184-0203	233.18	39.3	36184-0304	244.70	40.7	36184-0410	265.62	43.1	36184-0512	279.00	44.4
36186-0203	244.62	43.0	36186-0304	258.50	44.7	36186-0410	285.26	48.0	36186-0512	300.64	49.7
36189-0203	254.52	48.4	36189-0304	268.44	50.1	36189-0410	295.20	53.4	36189-0512	310.56	55.1
<div style="display: flex; justify-content: space-between;"> <div style="width: 24%;">  <p>32 Compartments (32) 3-3/16" x 3-27/32"</p> </div> <div style="width: 24%;">  <p>50 Compartments (2) 3-3/16" x 3-27/32" (8) 3-3/16" x 2-7/8" (8) 2-1/4" x 3-27/32" (32) 2-1/4" x 2-7/8"</p> </div> </div>											
36183-0724	\$299.40	44.0	36183-0940	\$342.72	47.0						
36184-0724	318.50	48.1	36184-0940	364.10	51.8						
36186-0724	347.04	54.6	36186-0940	398.68	59.5						
36189-0724	356.96	60.0	36189-0940	408.62	64.9						

Preconfigured 48" x 18" Drawers

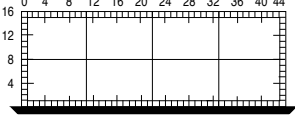
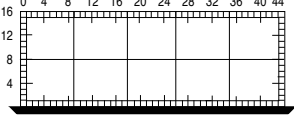
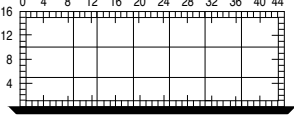
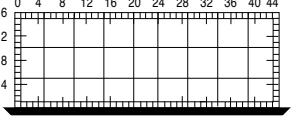
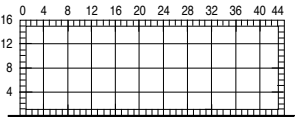
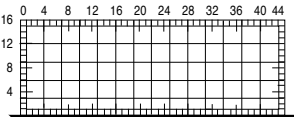
<div style="display: flex; justify-content: space-between;"> <div style="width: 24%;">  <p>8 Compartments (8) 10" x 7-11/16"</p> </div> <div style="width: 24%;">  <p>10 Compartments (8) 8-1/8" x 7-11/16" (2) 7-1/8" x 7-11/16"</p> </div> <div style="width: 24%;">  <p>21 Compartments (2) 6-1/8" x 5-3/4" (4) 6-1/8" x 4-13/16" (5) 5-1/8" x 5-3/4" (10) 5-1/8" x 4-13/16"</p> </div> <div style="width: 24%;">  <p>27 Compartments (8) 4-3/16" x 5-3/4" (16) 4-3/16" x 4-13/16" (1) 3-3/16" x 5-3/4" (2) 3-3/16" x 4-13/16"</p> </div> </div>											
48183-0304	\$311.86	42.5	48183-0405	\$323.00	43.6	48183-0614	\$356.66	44.6	48183-0818	\$381.28	49.3
48184-0304	317.96	46.2	48184-0405	329.86	47.6	48184-0614	365.68	49.0	48184-0818	392.36	54.4
48186-0304	335.18	51.4	48186-0405	349.06	53.1	48186-0614	394.76	55.1	48186-0818	425.16	62.1
48189-0304	349.56	58.1	48189-0405	363.48	59.8	48189-0614	409.14	61.8	48189-0818	439.56	68.8
<div style="display: flex; justify-content: space-between;"> <div style="width: 24%;">  <p>44 Compartments (44) 3-3/16" x 3-27/32"</p> </div> <div style="width: 24%;">  <p>70 Compartments (2) 3-3/16" x 3-27/32" (8) 3-3/16" x 2-7/8" (12) 2-1/4" x 3-27/32" (48) 2-1/4" x 2-7/8"</p> </div> </div>											
48183-1033	\$423.54	52.6	48183-1356	\$486.94	57.0						
48184-1033	445.30	58.5	48184-1356	503.46	63.9						
48186-1033	477.74	67.5	48186-1356	553.02	74.7						
48189-1033	492.12	74.2	48189-1356	567.40	81.4						

Preconfigured 36" x 24" Drawers

HD DRAWERS

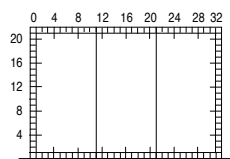
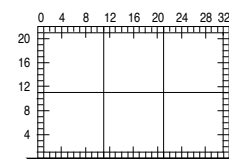
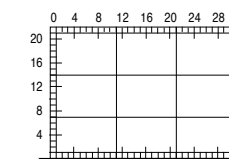
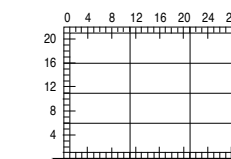
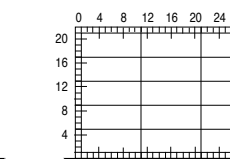
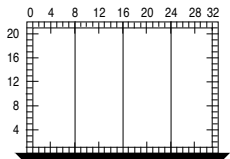
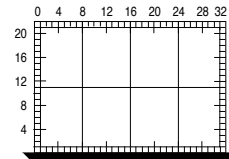
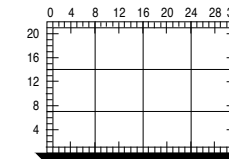
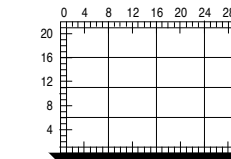
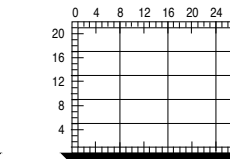
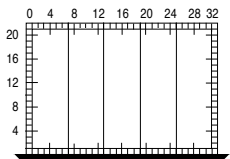
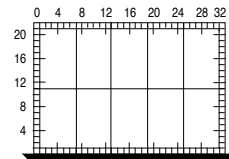
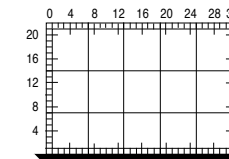
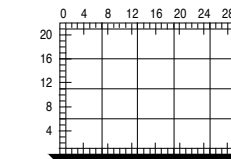
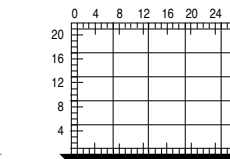
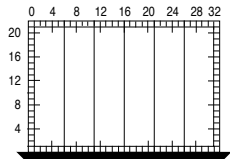
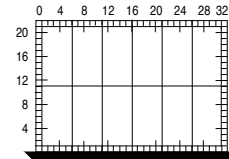
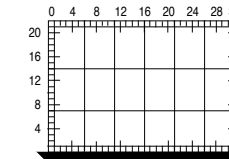
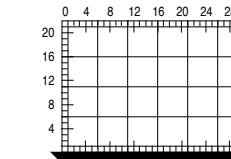
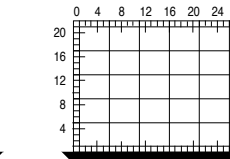
Catalog No.	List Price	Wt.	Catalog No.	List Price	Wt.	Catalog No.	List Price	Wt.	Catalog No.	List Price	Wt.	Catalog No.	List Price	Wt.
    														
3 Compartments (2) 10" x 21-1/2" (1) 9-1/6" x 21-1/2"			6 Compartments (4) 10" x 10-5/8" (2) 9-1/6" x 10-5/8"			9 Compartments (4) 10" x 6-3/4" (2) 10" x 7-11/16" (2) 9-1/6" x 6-3/4" (1) 9-1/6" x 7-11/16"			12 Compartments (4) 10" x 5-3/4" (4) 10" x 4-13/16" (2) 9-1/6" x 5-3/4" (2) 9-1/6" x 4-13/16"			15 Compartments (4) 10" x 4-13/16" (6) 10" x 3-27/32" (2) 9-1/6" x 4-13/16" (3) 9-1/6" x 3-27/32"		
36243-0200	\$221.38	39.5	36243-0203	\$227.12	40.2	36243-0206	\$232.86	41.0	36243-0209	\$238.60	41.7	36243-0212	\$244.36	42.4
36244-0200	239.92	42.4	36244-0203	246.26	43.4	36244-0206	252.58	44.4	36244-0209	258.90	45.4	36244-0212	265.28	46.5
36246-0200	249.68	46.2	36246-0203	260.06	47.7	36246-0206	270.42	49.2	36246-0209	280.78	50.8	36246-0212	291.16	52.3
36249-0200	264.48	52.7	36249-0203	274.88	54.2	36249-0206	285.22	55.7	36249-0209	295.60	57.2	36249-0212	305.96	58.7
    														
4 Compartments (4) 7-1/8" x 21-1/2"			8 Compartments (8) 7-1/8" x 10-5/8"			12 Compartments (8) 7-1/8" x 6-3/4" (4) 7-1/8" x 7-11/16"			16 Compartments (8) 7-1/8" x 5-3/4" (8) 7-1/8" x 4-13/16"			20 Compartments (8) 7-1/8" x 4-13/16" (12) 7-1/8" x 3-27/32"		
36243-0300	\$231.48	41.1	36243-0304	\$238.70	41.8	36243-0308	\$245.94	42.5	36243-0312	\$253.18	43.3	36243-0316	\$260.38	44.0
36244-0300	250.36	44.2	36244-0304	258.10	45.2	36244-0308	265.86	46.2	36244-0312	273.60	47.2	36244-0316	281.34	49.9
36246-0300	262.40	48.5	36246-0304	274.28	50.0	36246-0308	286.26	51.4	36246-0312	298.14	53.1	36246-0316	310.06	54.6
36249-0300	277.20	55.0	36249-0304	289.16	56.5	36249-0308	301.04	58.0	36249-0312	313.00	59.5	36249-0316	324.90	61.0
    														
5 Compartments (2) 6-1/8" x 21-1/2" (3) 5-1/8" x 21-1/2"			10 Compartments (4) 6-1/8" x 10-5/8" (6) 5-1/8" x 10-5/8"			15 Compartments (2) 6-1/8" x 7-11/16" (4) 6-1/8" x 6-3/4" (3) 5-1/8" x 7-11/16" (6) 5-1/8" x 6-3/4"			20 Compartments (4) 6-1/8" x 5-3/4" (4) 6-1/8" x 4-13/16" (6) 5-1/8" x 5-3/4" (6) 5-1/8" x 4-13/16"			25 Compartments (4) 6-1/8" x 4-13/16" (6) 6-1/8" x 3-27/32" (6) 5-1/8" x 4-13/16" (9) 5-1/8" x 3-27/32"		
36243-0400	\$241.56	42.6	36243-0405	\$249.92	43.3	36243-0410	\$258.32	44.1	36243-0415	\$266.66	44.8	36243-0420	\$275.06	45.5
36244-0400	260.90	46.0	36244-0405	270.14	47.0	36244-0410	279.38	48.0	36244-0415	288.64	49.0	36244-0420	297.90	50.1
36246-0400	275.10	50.8	36246-0405	288.28	52.3	36246-0410	301.40	53.8	36246-0415	314.60	55.3	36246-0420	327.76	56.8
36249-0400	289.90	57.3	36249-0405	303.06	58.8	36249-0410	316.24	60.3	36249-0415	329.40	61.8	36249-0420	342.56	63.3
    														
6 Compartments (2) 5-1/8" x 21-1/2" (4) 4-3/16" x 21-1/2"			12 Compartments (4) 5-1/8" x 10-5/8" (8) 4-3/16" x 10-5/8"			18 Compartments (2) 5-1/8" x 7-11/16" (4) 5-1/8" x 6-3/4" (4) 4-3/16" x 7-11/16" (8) 4-3/16" x 6-3/4"			24 Compartments (4) 5-1/8" x 5-3/4" (4) 5-1/8" x 4-13/16" (8) 4-3/16" x 5-3/4" (8) 4-3/16" x 4-13/16"			30 Compartments (4) 5-1/8" x 4-13/16" (6) 5-1/8" x 3-27/32" (8) 4-3/16" x 4-13/16" (12) 4-3/16" x 3-27/32"		
36243-0500	\$251.64	44.2	36243-0506	\$261.30	44.9	36243-0512	\$270.90	45.6	36243-0518	\$280.54	46.4	36243-0524	\$290.18	47.1
36244-0500	271.34	47.8	36244-0506	282.28	48.8	36244-0512	293.20	49.8	36244-0518	304.10	50.9	36244-0524	315.04	51.9
36246-0500	287.84	53.2	36246-0506	302.46	54.9	36246-0512	317.10	56.1	36246-0518	331.78	57.6	36246-0524	346.44	59.1
36249-0500	302.64	59.6	36249-0506	317.26	61.4	36249-0512	331.92	62.6	36249-0518	346.58	64.1	36249-0524	361.24	65.6

NOTE: 9" high drawers use 6" high partitions and dividers.

Preconfigured 36" x 24" Drawers

HD DRAWERS

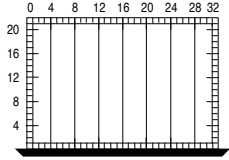
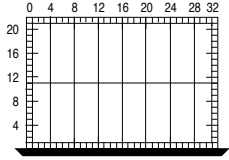
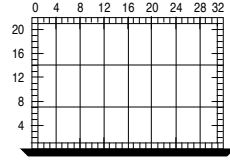
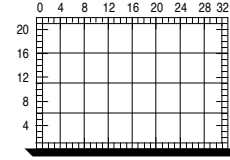
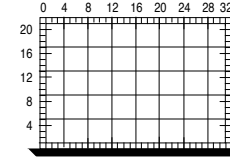
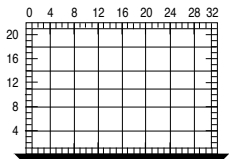
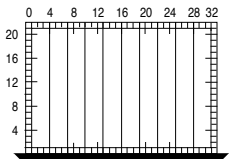
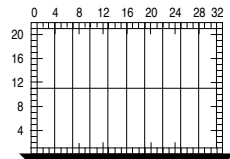
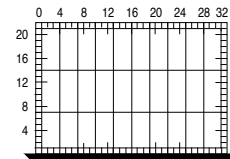
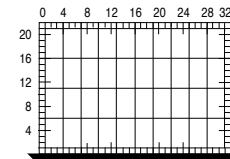
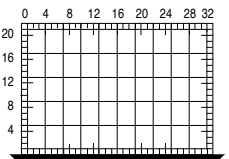
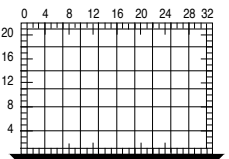
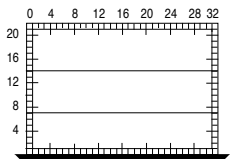
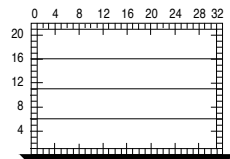
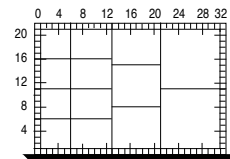
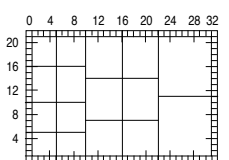
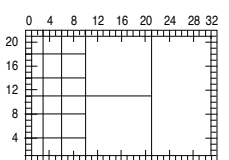
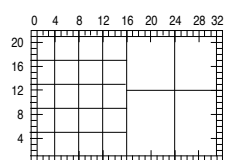
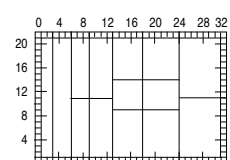
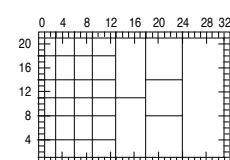
Catalog No.	List Price	Wt.	Catalog No.	List Price	Wt.	Catalog No.	List Price	Wt.	Catalog No.	List Price	Wt.	Catalog No.	List Price	Wt.
    														
8 Compartments (8) 3-3/16" x 21-1/2"			16 Compartments (16) 3-3/16" x 10-5/8"			24 Compartments (8) 3-3/16" x 7-11/16" (16) 3-3/16" x 6-3/4"			32 Compartments (16) 3-3/16" x 5-3/4" (16) 3-3/16" x 4-13/16"			40 Compartments (16) 3-3/16" x 4-13/16" (24) 3-3/16" x 3-27/32"		
36243-0700	\$271.84	47.3	36243-0708	\$284.28	48.0	36243-0716	\$296.70	48.7	36243-0724	\$309.08	49.4	36243-0732	\$321.52	50.2
36244-0700	292.40	51.5	36244-0708	306.02	52.5	36244-0716	319.74	53.5	36244-0724	333.48	54.5	36244-0732	347.14	55.5
36246-0700	313.24	57.8	36246-0708	330.28	59.2	36246-0716	347.26	60.7	36246-0724	364.28	62.2	36246-0732	381.26	63.7
36249-0700	328.04	64.2	36249-0708	345.06	65.7	36249-0716	362.06	67.2	36249-0724	380.16	68.6	36249-0732	396.04	70.1
    														
48 Compartments (32) 3-3/16" x 3-27/32" (16) 3-3/16" x 2-7/8"			10 Compartments (2) 3-3/16" x 21-1/2" (8) 2-1/4" x 21-1/2"			20 Compartments (4) 3-3/16" x 10-5/8" (16) 2-1/4" x 10-5/8"			30 Compartments (2) 3-3/16" x 7-11/16" (4) 3-3/16" x 6-3/4" (8) 2-1/4" x 7-11/16" (16) 2-1/4" x 6-3/4"			40 Compartments (4) 3-3/16" x 5-3/4" (4) 3-3/16" x 4-13/16" (16) 2-1/4" x 5-3/4" (16) 2-1/4" x 4-13/16"		
36243-0740	\$333.96	50.9	36243-0900	\$291.98	50.4	36243-0910	\$307.26	51.1	36243-0920	\$322.56	51.8	36243-0930	\$337.84	52.5
36244-0740	360.86	56.4	36244-0900	313.38	55.1	36244-0910	329.94	56.1	36244-0920	346.58	57.1	36244-0930	363.20	58.1
36246-0740	398.22	65.1	36246-0900	338.70	62.4	36246-0910	358.14	63.9	36246-0920	377.60	65.3	36246-0930	397.10	66.8
36249-0740	413.06	71.6	36249-0900	353.50	68.8	36249-0910	372.94	70.3	36249-0920	392.46	71.8	36249-0930	411.88	73.2
    														
50 Compartments (4) 3-3/16" x 4-13/16" (6) 3-3/16" x 3-27/32" (16) 2-1/4" x 13/16" (24) 2-1/4" x 3-27/32"			60 Compartments (8) 3-3/16" x 3-27/32" (4) 3-3/16" x 2-7/8" (32) 2-1/4" x 3-27/32" (16) 2-1/4" x 2-7/8"			3 Compartments (1) 30-1/2" x 7-11/16" (2) 30-1/2" x 6-3/4" Designed for partitions only			4 Compartments (2) 30-1/2" x 5-3/4" (2) 30-1/2" x 4-13/16" Designed for partitions only			13 Compartments		
36243-0940	\$353.12	53.3	36243-0950	\$368.40	54.0	36243-L200	\$228.50	40.4	36243-L300	\$242.12	42.4	36243-V309	\$247.12	42.6
36244-0940	379.82	59.0	36244-0950	396.38	60.0	36244-L200	247.30	44.2	36244-L300	261.50	47.0	36244-V309	267.52	46.3
36246-0940	416.52	68.2	36246-0950	436.02	69.7	36246-L200	259.06	48.6	36246-L300	276.48	52.1	36246-V309	287.78	51.6
36249-0940	431.38	74.7	36249-0950	450.82	76.1	36249-L200	273.88	55.3	36249-L300	291.28	58.5	36249-V309	302.60	58.1
    														
16 Compartments			21 Compartments			24 Compartments			14 Compartments			30 Compartments		
36243-V411	\$259.52	44.1	36243-V416	\$266.46	44.0	36243-V518	\$280.10	46.0	36243-V607	\$273.08	46.6	36243-V623	\$297.22	47.6
36244-V411	281.18	48.0	36244-V416	288.02	47.9	36244-V518	302.64	50.3	36244-V607	294.46	50.8	36244-V623	320.62	52.2
36246-V411	303.00	53.8	36246-V416	308.28	53.6	36246-V518	327.80	56.9	36246-V607	317.42	57.2	36246-V623	347.20	59.2
36249-V411	317.80	60.3	36249-V416	323.10	60.1	36249-V518	342.58	63.3	36249-V607	332.24	63.6	36249-V623	362.04	65.7

Preconfigured 48" x 24" Drawers

HD DRAWERS

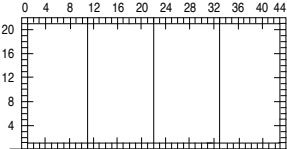
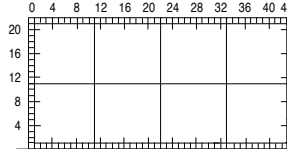
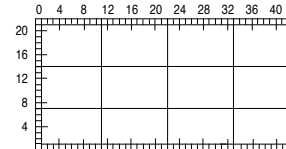
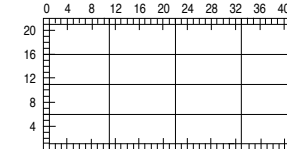
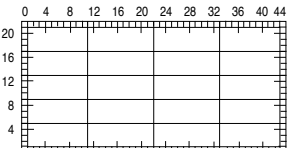
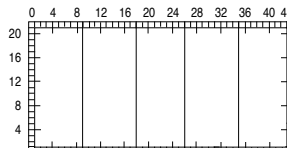
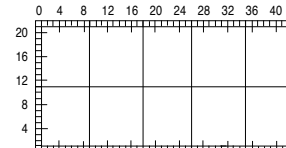
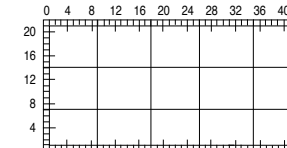
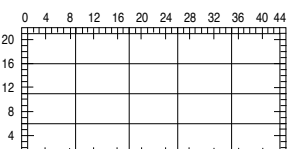
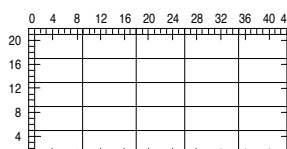
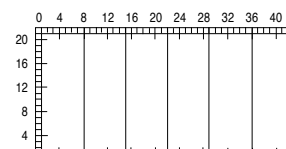
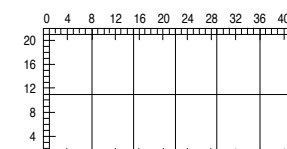
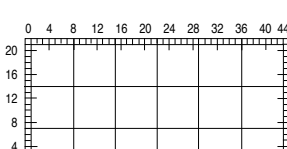
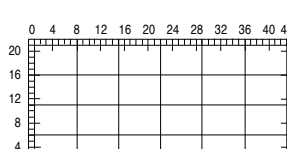
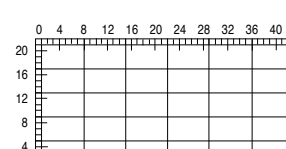
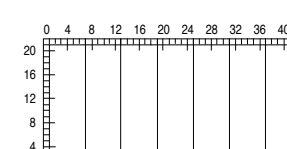
Catalog No.	List Price	Wt.	Catalog No.	List Price	Wt.	Catalog No.	List Price	Wt.	Catalog No.	List Price	Wt.
											
4 Compartments (4) 10" x 21-1/2"											
48243-0300	\$287.60	46.2	48243-0304	\$295.36	47.2	48243-0308	\$303.06	48.2	48243-0312	\$310.80	49.3
48244-0300	311.48	50.1	48244-0304	319.98	51.5	48244-0308	328.40	52.9	48244-0312	336.94	54.3
48246-0300	324.96	55.8	48246-0304	339.06	57.8	48246-0308	353.14	59.9	48246-0312	367.22	62.0
48249-0300	343.86	63.6	48249-0304	357.94	65.7	48249-0308	372.04	67.8	48249-0312	386.12	69.9
											
8 Compartments (8) 10" x 10-5/8"											
											
12 Compartments (4) 10" x 7-11/16" (8) 10" x 6-3/4"											
											
16 Compartments (8) 10" x 5-3/4" (8) 10" x 4-13/16"											
											
20 Compartments (8) 10" x 4-13/16" (12) 10" x 3-27/32"											
											
5 Compartments (4) 8-1/6" x 21-1/2" (1) 7-1/8" x 21-1/2"											
											
10 Compartments (8) 8-1/6" x 10-5/8" (2) 7-1/8" x 10-5/8"											
											
15 Compartments (4) 8-1/6" x 7-11/16" (8) 8-1/6" x 6-3/4" (1) 7-1/8" x 7-11/16" (2) 7-1/8" x 6-3/4"											
48243-0316	\$318.54	50.3	48243-0400	\$297.68	47.8	48243-0405	\$306.86	48.8	48243-0410	\$316.02	49.8
48244-0316	345.40	55.7	48244-0400	321.96	51.9	48244-0405	332.24	53.3	48244-0410	342.56	54.7
48246-0316	381.30	64.1	48246-0400	337.68	58.1	48246-0405	353.38	60.1	48246-0410	369.02	62.2
48249-0316	400.16	72.0	48249-0400	356.56	65.9	48249-0405	372.20	68.0	48249-0410	387.88	70.1
											
20 Compartments (8) 8-1/6" x 5-3/4" (8) 8-1/6" x 4-13/16" (2) 7-1/8" x 5-3/4" (2) 7-1/8" x 4-13/16"											
											
25 Compartments (8) 8-1/6" x 4-13/16" (12) 8-1/6" x 3-27/32" (2) 7-1/8" x 4-13/16" (3) 7-1/8" x 3-27/32"											
											
6 Compartments (2) 7-1/8" x 21-1/2" (4) 6-1/8" x 21-1/2"											
											
12 Compartments (4) 7-1/8" x 10-5/8" (8) 6-1/8" x 10-5/8"											
48243-0415	\$325.18	50.8	48243-0420	\$334.36	51.8	48243-0500	\$307.72	49.3	48243-0506	\$318.24	50.3
48244-0415	352.86	56.1	48244-0420	363.18	57.5	48244-0500	332.44	53.7	48244-0506	343.80	55.1
48246-0415	384.68	64.3	48246-0420	400.34	66.4	48246-0500	350.44	60.4	48246-0506	367.26	62.4
48249-0415	403.56	72.2	48249-0420	419.26	74.2	48249-0500	369.26	68.2	48249-0506	386.18	70.3
											
18 Compartments (2) 7-1/8" x 7-11/16" (4) 7-1/8" x 6-3/4" (4) 6-1/8" x 7-11/16" (8) 6-1/8" x 6-3/4"											
											
24 Compartments (4) 7-1/8" x 5-3/4" (4) 7-1/8" x 4-13/16" (8) 6-1/8" x 5-3/4" (8) 6-1/8" x 4-13/16"											
											
30 Compartments (4) 7-1/8" x 4-13/16" (6) 7-1/8" x 3-27/32" (8) 6-1/8" x 4-13/16" (12) 6-1/8" x 3-27/32"											
											
7 Compartments (2) 6-1/8" x 21-1/2" (5) 5-1/8" x 21-1/2"											
48243-0512	\$328.70	51.3	48243-0518	\$339.12	52.4	48243-0524	\$349.64	53.4	48243-0600	\$317.84	50.9
48244-0512	355.12	56.5	48244-0518	366.48	57.9	48244-0524	377.86	59.3	48244-0600	342.96	55.5
48246-0512	384.18	64.5	48246-0518	401.00	66.6	48246-0524	417.92	68.7	48246-0600	363.12	62.7
48249-0512	402.98	72.4	48249-0518	419.90	74.4	48249-0524	436.78	76.5	48249-0600	381.98	70.6

NOTE: 9" high drawers use 6" high partitions and dividers.

Preconfigured 48" x 24" Drawers

HD DRAWERS

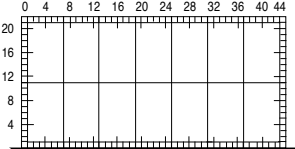
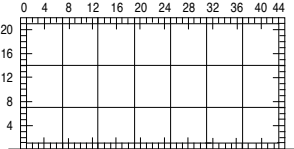
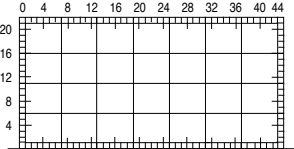
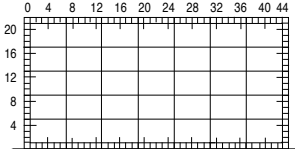
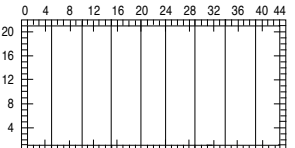
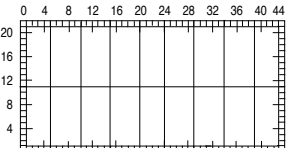
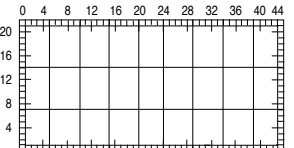
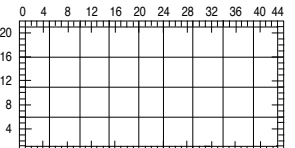
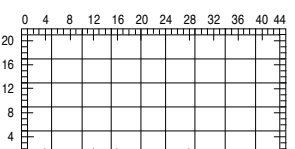
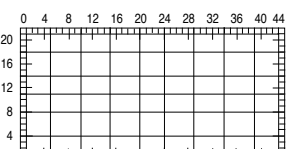
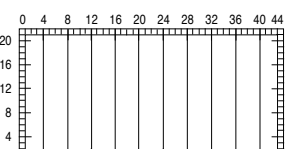
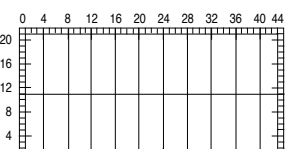
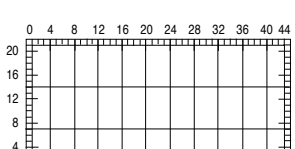
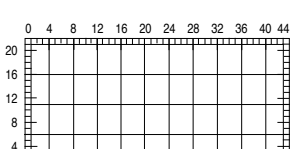
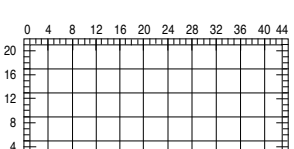
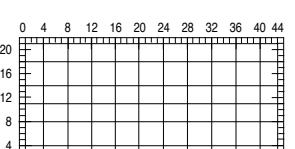
Catalog No.	List Price	Wt.	Catalog No.	List Price	Wt.	Catalog No.	List Price	Wt.	Catalog No.	List Price	Wt.
											
14 Compartments (4) 6-1/8" x 19-5/8" (10) 5-1/8" x 10-5/8"			21 Compartments ((2) 6-1/8" x 7-11/16" (4) 6-1/8" x 6-3/4" (5) 5-1/8" x 7-11/16" (10) 5-1/8" x 6-3/4"			28 Compartments (4) 6-1/8" x 5-3/4" (4) 6-1/8" x 4-13/16" (10) 5-1/8" x 5-3/4" (10) 5-1/8" x 4-13/16"			35 Compartments (4) 6-1/8" x 4-13/16" (6) 6-1/8" x 3-27/32" (10) 5-1/8" x 4-13/16" (15) 5-1/8" x 3-27/32"		
48243-0607	\$329.52	51.9	48243-0614	\$341.16	52.9	48243-0621	\$352.86	53.9	48243-0628	\$364.52	54.9
48244-0607	355.88	56.9	48244-0614	368.80	58.3	48244-0621	381.74	59.7	48244-0628	394.68	61.1
48246-0607	381.42	64.8	48246-0614	399.72	66.8	48246-0621	418.02	68.9	48246-0628	436.32	70.9
48249-0607	400.30	72.6	48249-0614	418.56	74.7	48249-0621	436.86	76.7	48249-0628	455.18	78.8
											
9 Compartments (8) 4-3/16" x 21-1/2" (1) 3-3/16" x 21-1/2"			18 Compartments (16) 4-3/16" x 10-5/8" (2) 3-3/16" x 10-5/8"			27 Compartments (8) 4-3/16" x 7-11/16" (16) 4-3/16" x 6-3/4" (1) 3-3/16" x 7-11/16" (2) 3-3/16" x 6-3/4"			36 Compartments (16) 4-3/16" x 5-3/4" (16) 4-3/16" x 4-13/16" (2) 3-3/16" x 5-3/4" (2) 3-3/16" x 4-13/16"		
48243-0800	\$338.00	54.0	48243-0809	\$352.26	55.0	48243-0818	\$366.48	56.0	48243-0827	\$380.72	57.0
48244-0800	363.96	59.1	48244-0809	380.10	60.5	48244-0818	396.28	61.9	48244-0827	412.44	63.3
48246-0800	388.54	67.3	48246-0809	409.74	69.4	48246-0818	430.84	71.4	48246-0827	451.96	73.5
48249-0800	407.44	75.2	48249-0809	428.58	77.2	48249-0818	449.76	79.3	48249-0827	470.86	81.3
											
45 Compartments (16) 4-3/16" x 4-13/16" (24) 4-3/16" x 3-27/32" (2) 3-3/16" x 4-13/16" (3) 3-3/16" x 3-27/32"			54 Compartments (32) 4-3/16" x 3-27/32" (16) 4-3/16" x 2-7/8" (4) 3-3/16" x 3-27/32" (2) 3-3/16" x 2-7/8"			11 Compartments (11) 3-3/16" x 21-1/2"			22 Compartments (22) 3-3/16" x 10-5/8"		
48243-0836	\$394.94	58.0	48243-0845	\$409.20	59.0	48243-1000	\$358.18	57.1	48243-1011	\$375.26	58.1
48244-0836	428.60	64.7	48244-0845	444.80	66.1	48244-1000	384.92	62.8	48244-1011	403.74	64.2
48246-0836	473.16	75.5	48246-0845	494.28	77.5	48246-1000	414.00	71.9	48246-1011	437.38	74.0
48249-0836	492.04	83.4	48249-0845	513.18	85.4	48249-1000	432.84	79.8	48249-1011	456.20	81.8
											
33 Compartments (11) 3-3/16" x 7-11/16" (22) 3-3/16" x 6-3/4"			44 Compartments (22) 3-3/16" x 5-3/4" (22) 3-3/16" x 4-13/16"			55 Compartments (22) 3-3/16" x 4-13/16" (33) 3-3/16" x 3-27/32"			66 Compartments (44) 3-3/16" x 3-27/32" (22) 3-3/16" x 2-7/8"		
48243-1022	\$392.36	59.1	48243-1033	\$409.46	60.1	48243-1044	\$426.54	61.1	48243-1055	\$443.62	62.1
48244-1022	422.60	65.5	48244-1033	441.42	66.9	48244-1044	460.26	68.3	48244-1055	479.08	69.6
48246-1022	460.72	76.0	48246-1033	484.12	78.0	48246-1044	507.46	80.1	48246-1055	530.82	82.1
48249-1022	479.58	83.9	48249-1033	502.92	85.9	48249-1044	526.34	87.9	48249-1055	549.70	89.9

Preconfigured 48" x 24" Drawers

HD DRAWERS

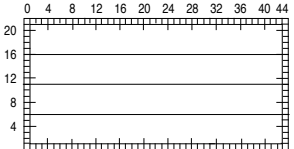
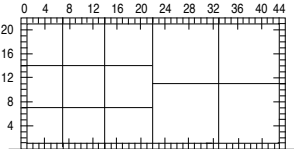
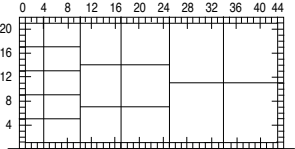
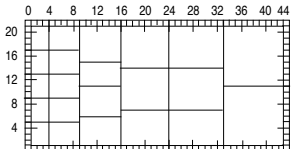
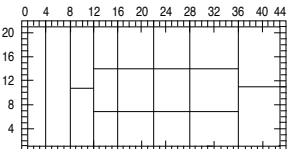
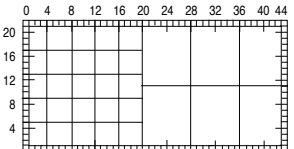
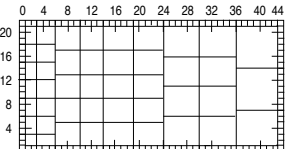
Catalog No.	List Price	Wt.	Catalog No.	List Price	Wt.	Catalog No.	List Price	Wt.	Catalog No.	List Price	Wt.
 <p>3 Compartments (1) 42-1/4" x 7-11/16" (2) 42-1/4" x 6-3/4"</p> <p>Designed for partitions only.</p>			 <p>4 Compartments (2) 42-1/4" x 5-3/4" (2) 42-1/4" x 4-13/16"</p> <p>Designed for partitions only.</p>			 <p>13 Compartments</p>			 <p>20 Compartments</p>		
48243-L200	\$293.94	45.5	48243-L300	\$312.24	47.5	48243-V408	\$312.00	49.3	48243-V514	\$331.32	51.4
48244-L200	317.96	50.6	48244-L300	336.94	54.6	48244-V408	337.54	54.0	48244-V514	358.44	56.5
48246-L200	333.00	56.8	48246-L300	356.10	60.8	48246-V408	361.60	61.2	48246-V514	387.08	64.6
48249-L200	351.88	64.7	48249-L300	374.98	68.7	48249-V408	380.46	69.0	48249-V514	405.98	72.4
 <p>22 Compartments</p>			 <p>18 Compartments</p>			 <p>31 Compartments</p>			 <p>45 Compartments</p>		
48243-V516	\$364.56	51.7	48243-V710	\$344.62	53.8	48243-V723	\$364.42	54.8	48243-V836	\$394.88	57.6
48244-V516	332.44	56.9	48244-V710	371.74	59.2	48244-V723	393.46	60.6	48244-V836	426.76	64.2
48246-V516	392.46	65.2	48246-V710	401.42	67.8	48246-V723	427.30	69.8	48246-V836	468.80	74.7
48249-V516	411.30	73.0	48249-V710	420.30	75.7	48249-V723	446.16	77.7	48249-V836	487.62	82.6

NOTE: 9" high drawers use 6" high partitions and dividers.

Plastic Bins



Catalog No.	Length	Width	Depth	List Price	Wt.
A808A	2-1/2"	2-1/2"	2-1/8"	\$2.14	0.1
A808B	2-1/2"	5"	2-1/8"	2.74	0.1
N80	6-1/8"	6-1/8"	2-1/4"	4.36	0.2
N80-DIV*	5-15/16"	1/16"	1-15/16"	0.72	0.1

*Subdivides N80 into two or four compartments using one or two dividers.

Maximum Number of Containers Per Drawer Size

Catalog No.	36" x 18"	36" x 24"	48" x 18"	48" x 24"
A808A	72	96	102	136
A808B	36	48	51	68
N80	10	15	14	21

Catalog No.	Length	Width	Depth	List Price	Wt.
10561-002-000 (for 4" drawer)	3-3/8"	3-3/8"	3-1/8"	\$2.90	0.1
10561-001-000 (for 6" drawer)	5-5/16"	3"	4-9/16"	3.48	0.2

Maximum Number of Bins Per Drawer Size

Catalog No.	36" x 18"	36" x 24"	48" x 18"	48" x 24"
10561-002-000	45	54	70	84
10561-001-000	24	32	36	48

NOTE: Plastic bins available in light gray plastic only.

Preconfigured Kits (includes 3" drawer, slides and bins)

Catalog No.	Description	List Price	Wt.
36183-PB1	36" x 18" x 3" Drawer 2 rows of 12 A808A 2 rows of 12 A808B	\$310.44	19.4
36243-PB2	36" x 24" x 3" Drawer 2 rows of 12 A808A 2 rows of 12 A808B 1 row of 5 N80	\$339.38	23.3
48183-PB3	48" x 18" x 3" Drawer 2 rows of 17 A808A 2 rows of 17 A808B	\$439.94	25.8
48243-PB4	48" x 24" x 3" Drawer 2 rows of 17 A808A 2 rows of 17 A808B 1 row of 7 N80	\$470.30	30.9

Configure Your Own . . .

HD DRAWERS

Drawers (basic drawer includes suspension only; no partitions or dividers)

Catalog No.	Size	List Price	Wt.
36183-0000	36" x 18" x 3" high	\$193.96	14.5
36184-0000	36" x 18" x 4-1/2" high	206.64	16.5
36186-0000	36" x 18" x 6" high	209.50	18.9
36189-0000	36" x 18" x 9" high	219.46	24.3
36243-0000	36" x 24" x 3" high	\$201.20	17.3
36244-0000	36" x 24" x 4-1/2" high	218.88	19.6
36246-0000	36" x 24" x 6" high	224.26	22.5
36249-0000	36" x 24" x 9" high	239.06	28.9
48183-0000	48" x 18" x 3" high	\$274.92	18.9
48184-0000	48" x 18" x 4-1/2" high	279.08	21.6
48186-0000	48" x 18" x 6" high	283.96	25.0
48189-0000	48" x 18" x 9" high	298.34	31.7
48243-0000	48" x 24" x 3" high	\$257.36	22.4
48244-0000	48" x 24" x 4-1/2" high	279.98	25.5
48246-0000	48" x 24" x 6" high	286.86	29.7
48249-0000	48" x 24" x 9" high	305.70	37.6

NOTE: 9" high drawers use 6" high partitions and dividers

Partitions

Catalog No.	Size	List Price	Wt.
For Front-to-Back			
•10545-000-161	18" deep x 3" high	\$9.74	1.2
•10545-001-161	18" deep x 4-1/2" high	10.14	1.4
•10545-002-161	18" deep x 6" high	12.40	1.7
•10546-000-161	24" deep x 3" high	\$10.12	1.6
•10546-001-161	24" deep x 4-1/2" high	10.54	1.8
•10546-002-161	24" deep x 6" high	12.74	2.3
For Left-to-Right			
10530-000-161	36" wide x 3" high	\$13.68	1.4
10530-001-161	36" wide x 4-1/2" high	14.26	1.9
10530-002-161	36" wide x 6" high	17.42	2.7
10531-000-161	48" wide x 3" high	\$18.32	2.0
10531-001-161	48" wide x 4-1/2" high	19.02	2.6
10531-002-161	48" wide x 6" high	23.16	3.8

NOTE: Left-to-Right partitions do not accept dividers

Dividers

Catalog No.	Size	List Price	Wt.
•10533-000-000	3 slots x 3" high	\$1.56	0.1
•10534-000-000	4 slots x 3" high	1.58	0.1
•10535-000-000	5 slots x 3" high	1.62	0.1
•10536-000-000	6 slots x 3" high	1.66	0.1
•10537-000-000	7 slots x 3" high	1.74	0.2
•10538-000-000	8 slots x 3" high	1.84	0.2
•10539-000-000	9 slots x 3" high	1.86	0.2
•10540-000-000	10 slots x 3" high	1.88	0.2
•10541-000-000	11 slots x 3" high	1.96	0.3
•10542-000-000	12 slots x 3" high	2.16	0.3
•10543-000-000	13 slots x 3" high	2.18	0.3
•10533-001-000	3 slots x 4-1/2" high	\$1.66	0.1
•10534-001-000	4 slots x 4-1/2" high	1.74	0.1
•10535-001-000	5 slots x 4-1/2" high	1.84	0.2
•10536-001-000	6 slots x 4-1/2" high	1.86	0.2
•10537-001-000	7 slots x 4-1/2" high	1.88	0.2
•10538-001-000	8 slots x 4-1/2" high	1.96	0.3
•10539-001-000	9 slots x 4-1/2" high	2.16	0.3
•10540-001-000	10 slots x 4-1/2" high	2.16	0.3
•10541-001-000	11 slots x 4-1/2" high	2.18	0.4
•10542-001-000	12 slots x 4-1/2" high	2.26	0.4
•10543-001-000	13 slots x 4-1/2" high	2.44	0.4
•10533-002-000	3 slots x 6" high	\$1.94	0.1
•10534-002-000	4 slots x 6" high	2.18	0.2
•10535-002-000	5 slots x 6" high	2.44	0.2
•10536-002-000	6 slots x 6" high	2.60	0.3
•10537-002-000	7 slots x 6" high	2.76	0.3
•10538-002-000	8 slots x 6" high	3.02	0.4
•10539-002-000	9 slots x 6" high	3.18	0.4
•10540-002-000	10 slots x 6" high	3.38	0.5
•10541-002-000	11 slots x 6" high	3.52	0.5
•10542-002-000	12 slots x 6" high	3.82	0.6
•10543-002-000	13 slots x 6" high	4.08	0.6

1 slot = approximately 1"

Mounting Upright Sets (for Borroughs' Angle or Beaded Post)

Catalog No.	Size	List Price	Wt.
10500-000	18" high	\$49.20/set	4.7
10500-001	24" high	\$61.80/set	6.2
10500-002	36" high	\$81.22/set	9.3
10500-003	48" high	\$105.76/set	12.4

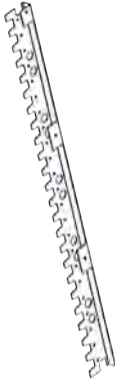
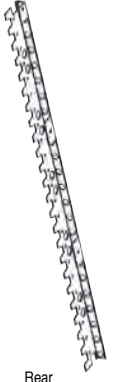
NOTE: Four uprights per set; two front and two rear. Please specify color.

Snap-On Plastic Label Holder for Dividers

Catalog No.	Size	List Price	Wt.
10153-001-000	2-3/4" x 7/8" gray	\$1.20	0.1
10153-000-000	2-3/4" x 7/8" white	\$1.20	0.1



• InStock: Dividers in Galvanized Steel
Partitions in #161 Mist Gray

RTA Storage Cabinets & Back Room Storage

Storage Cabinets

	Catalog No.	Description	Wt.	List Price
		78" High x 36" Wide x 18" Deep		
	•10870-000	Storage Cabinet with four adjustable shelves	155.0	\$812.18
		78" High x 36" Wide x 24" Deep		
	•10870-001	Storage Cabinet with four adjustable shelves	180.0	\$948.94
		Extra Shelves		
	•10857-000	36" x 18" Shelves - pairs only	14.5	\$82.08
	•10857-001	36" x 24" Shelves - pairs only	18.5	95.48

RTA Storage Cabinets - are designed for back room, mail room or general purpose storage applications. Cabinets are standard with a 3-point locking system. Shipped Ready-To-Assemble (RTA) with superior packaging that allows for maximum protection.

• InStock in #161 Mist Gray

STORAGE CABINETS

RTA Clip-Type Shelving Open & Closed Type

	Catalog No.	Description	Wt.	List Price	Catalog No.	Description	Wt.	List Price
	Open Type				Closed Type			
	5 Shelf Units ♦ 6' High				5 Shelf Units ♦ 6' High			
	•CO5-36126	36" x 12"	52.2	\$169.42	CC5-36126	36" x 12"	84.6	\$342.02
	•CO5-36186	36" x 18"	62.2	200.98	CC5-36186	36" x 18"	100.2	389.46
	•CO5-36246	36" x 24"	72.2	234.74	CC5-36246	36" x 24"	117.2	460.10
	5 Shelf Units ♦ 7' High				5 Shelf Units ♦ 7' High			
	•CO5-36127	36" x 12"	55.0	\$176.00	CC5-36127	36" x 12"	92.6	\$362.04
	•CO5-36187	36" x 18"	65.0	207.50	CC5-36187	36" x 18"	109.2	411.82
	•CO5-36247	36" x 24"	75.0	241.32	CC5-36247	36" x 24"	127.0	485.74
	6 Shelf Units ♦ 6' High				6 Shelf Units ♦ 6' High			
	•CO6-36126	36" x 12"	58.4	\$188.98	CC6-36126	36" x 12"	90.8	\$361.58
	•CO6-36186	36" x 18"	70.4	226.86	CC6-36186	36" x 18"	108.4	415.38
	•CO6-36246	36" x 24"	82.4	267.36	CC6-36246	36" x 24"	127.4	492.74
	6 Shelf Units ♦ 7' High				6 Shelf Units ♦ 7' High			
	•CO6-36127	36" x 12"	61.2	\$195.52	CC6-36127	36" x 12"	98.8	\$381.58
	•CO6-36187	36" x 18"	73.2	233.44	CC6-36187	36" x 18"	117.4	437.72
	•CO6-36247	36" x 24"	85.2	273.94	CC6-36247	36" x 24"	137.2	518.36
	Extra Shelves - Two Per Pack				Shelf Clip			
	•11025-006	36" x 12"	12.4	\$42.34	09531-099		.07	\$.78
	•11025-007	36" x 18"	16.4	54.98				
•11025-008	36" x 24"	20.4	68.46					

6 Shelf Open Unit

Standard Color:
#065 Industrial Gray

RTA Commercial Shelving - Is a durable, low-cost storage solution for back rooms, supply closets, mail rooms and utility rooms. Easily assembled; instructions included.

• InStock in #065 Industrial Gray

Panel Kits

	Catalog No.	Description	Wt.	List Price
Panel Kits - An open shelving unit can be converted to a closed shelving unit at any time by simply adding a panel kit.	11036-000	36" x 12" x 6'	37.0	\$172.62
	11036-001	36" x 18" x 6'	44.0	188.54
	11036-003	36" x 24" x 6'	54.0	225.38
	11037-000	36" x 12" x 7'	43.0	\$186.06
	11037-001	36" x 18" x 7'	51.0	204.30
	11037-003	36" x 24" x 7'	63.0	244.44

540 Series - Preconfigured Cabinets

27" High x 27-3/4" Deep - Standard Width and Extra Width

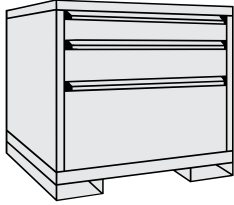

Drawers	Kits*
-100	K3
-140	K1
-300	K8

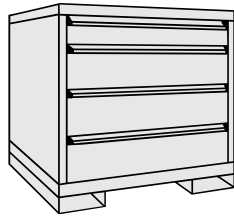

Drawers	Kits*
-100	K3
-140	K1
-140	K1
-160	K1

Specify color when ordering.

Standard Colors:

#065 Industrial Gray, #C386 Red, #B504 Blue, #161 Mist Gray, #445 White, #F604 Pebble and #040 Black

Drawer interiors are #161 Mist Gray.

Notes: *For kit configurations, see pages 29 & 30. Preconfigured units come standard with key lock, fork lift base and front & rear kickplates.

Modular Drawers are F.O.B. Kankakee, Illinois 60901. Customer is responsible for all freight charges from Kankakee, Illinois to destination.

Catalog No. Width Drawers Wt. List Price

Catalog No. Width Drawers Wt. List Price

Cabinets without Drawer Divider Kits

S0540-031	29"	3	194	\$1193.18
E0540-031	43"	3	291	1819.40

Cabinets without Drawer Divider Kits

S0540-041	29"	4	227	\$1327.38
E0540-041	43"	4	341	2072.14

Cabinets with Drawer Divider Kits

SR0540-031	29"	3	22	\$1312.84
ER0540-031	43"	3	33	2017.32

Cabinets with Drawer Divider Kits

SR0540-041	29"	4	264	\$1498.46
ER0540-041	43"	4	396	2351.70

600 Series - Preconfigured Cabinets

30" High x 27-3/4" Deep - Standard Width and Extra Width

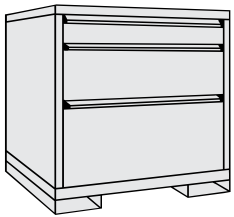

Drawers	Kits*
-100	K3
-200	K5
-300	K8

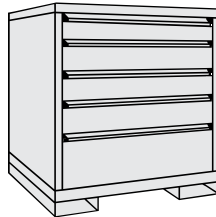

Drawers	Kits*
-100	K3
-100	K3
-100	K3
-100	K3
-200	K5

MODULAR DRAWERS

Catalog No. Width Drawers Wt. List Price

Catalog No. Width Drawers Wt. List Price

Cabinets without Drawer Divider Kits

S0600-031	29"	3	130	\$1230.08
E0600-031	43"	3	195	1878.66

Cabinets without Drawer Divider Kits

S0600-051	29"	5	267	\$1506.30
E0600-051	43"	5	400	2340.52

Cabinets with Drawer Divider Kits

SR0600-031	29"	3	162	\$1357.56
ER0600-031	43"	3	244	2095.60

Cabinets with Drawer Divider Kits

SR0600-051	29"	5	316	\$1736.66
ER0600-051	43"	5	474	2709.54

700 Series - Preconfigured Cabinets

33" High x 27-3/4" Deep - Standard Width and Extra Width

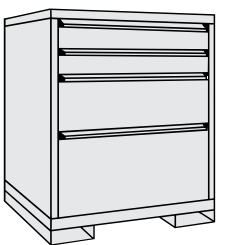

Drawers	Kits*
-100	K3
-100	K3
-200	K5
-300	K8

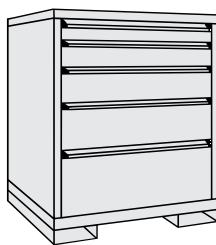

Drawers	Kits*
-80	K4
-100	K3
-120	K1
-160	K1
-240	K8

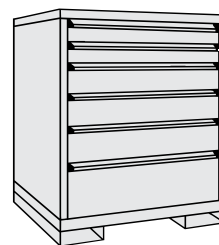

Drawers	Kits*
-80	K4
-80	K4
-100	K3
-120	K1
-120	K1
-200	K5

Catalog No. Width Drawers Wt. List Price

Catalog No. Width Drawers Wt. List Price

Catalog No. Width Drawers Wt. List Price

Cabinets without Drawer Divider Kits

S0700-041	29"	4	257	\$1431.36
E0700-041	43"	4	385	2221.98

Cabinets without Drawer Divider Kits

S0700-051	29"	5	294	\$1565.56
E0700-051	43"	5	437	2460.16

Cabinets without Drawer Divider Kits

S0700-061	29"	6	322	\$1707.58
E0700-061	43"	6	483	2683.80

Cabinets with Drawer Divider Kits

SR0700-041	29"	4	298	\$1603.58
ER0700-041	43"	4	447	2508.26

Cabinets with Drawer Divider Kits

SR0700-051	29"	5	364	\$1762.36
ER0700-051	43"	5	546	2788.92

Cabinets with Drawer Divider Kits

SR0700-061	29"	6	376	\$1967.02
ER0700-061	43"	6	565	3122.16

900 Series - Preconfigured Cabinets

41" High x 27-3/4" Deep - Standard Width and Extra Width

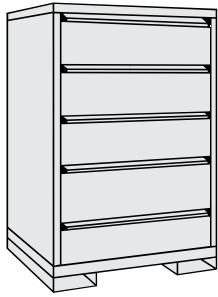

Drawers	Kits*
-180	K5
-180	K5
-180	K5
-180	K5
-180	K5

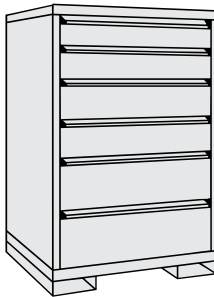

Drawers	Kits*
-120	K1
-120	K1
-140	K1
-140	K1
-180	K5
-200	K5

Specify color when ordering.

Standard Colors:

#065 Industrial Gray, #C386 Red, #B504 Blue, #161 Mist Gray, #445 White, #F604 Pebble and #040 Black

Drawer interiors are #161 Mist Gray.

Notes: *For kit configurations, see pages 29 & 30. Preconfigured units come standard with key lock, fork lift base and front & rear kickplates.

Modular Drawers are F.O.B. Kankakee, Illinois 60901. Customer is responsible for all freight charges from Kankakee, Illinois to destination.

Catalog No. Width Drawers Wt. List Price

Catalog No. Width Drawers Wt. List Price

Cabinets without Drawer Divider Kits

S0900-051	29"	5	308	\$1729.94
E0900-051	43"	5	462	2669.28

Cabinets without Drawer Divider Kits

S0900-061	29"	6	339	\$1841.78
E0900-061	43"	6	508	2877.28

Cabinets with Drawer Divider Kits

SR0900-051	29"	5	370	\$1973.72
ER0900-051	43"	5	555	3108.74

Cabinets with Drawer Divider Kits

SR0900-061	29"	6	401	\$2106.78
ER0900-061	43"	6	601	3333.52

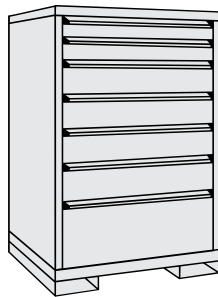

Drawers	Kits*
-80	K4
-80	K4
-120	K1
-120	K1
-120	K1
-140	K1
-240	K8

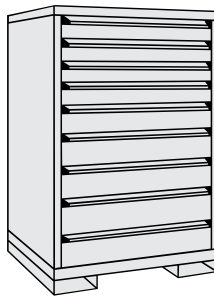

Drawers	Kits*
-80	K4
-80	K4
-80	K4
-80	K4
-100	K3
-120	K1
-120	K1
-120	K1

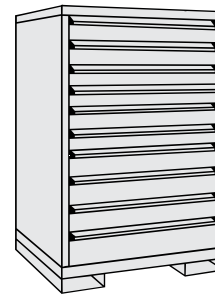

Drawers	Kits*
-80	K4
-80	K4
-80	K4
-80	K4
-80	K4
-80	K4
-100	K3
-100	K3
-100	K3
-120	K1

Catalog No. Width Drawers Wt. List Price

Catalog No. Width Drawers Wt. List Price

Catalog No. Width Drawers Wt. List Price

Cabinets without Drawer Divider Kits

S0900-071	29"	7	372	\$1960.30
E0900-071	43"	7	558	3071.84

Cabinets without Drawer Divider Kits

S0900-091	29"	9	437	\$2228.68
E0900-091	43"	9	656	3503.50

Cabinets without Drawer Divider Kits

S0900-101	29"	10	469	\$2362.88
E0900-101	43"	10	704	3712.60

Cabinets with Drawer Divider Kits

SR0900-071	29"	7	430	\$2116.86
ER0900-071	43"	7	646	3540.38

Cabinets with Drawer Divider Kits

SR0900-091	29"	9	512	\$2604.42
ER0900-091	43"	9	767	4134.18

Cabinets with Drawer Divider Kits

SR0900-101	29"	10	548	\$2784.44
ER0900-101	43"	10	822	4412.62

MODULAR DRAWERS

1000 Series - Preconfigured Cabinets

45" High x 27-3/4" Deep - Standard Width and Extra Width

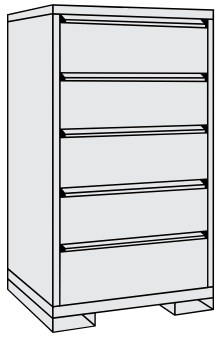

Drawers	Kits*
-200	K5
-200	K5
-200	K5
-200	K5
-200	K5

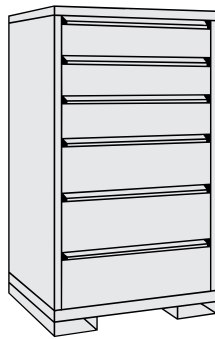

Drawers	Kits*
-120	K1
-140	K1
-160	K1
-180	K5
-200	K5
-200	K5

Specify color when ordering.

Standard Colors:

#065 Industrial Gray, #C386 Red, #B504 Blue, #161 Mist Gray, #445 White, #F604 Pebble and #040 Black

Drawer interiors are #161 Mist Gray.

Notes: *For kit configurations, see pages 29 & 30. Preconfigured units come standard with key lock, fork lift base and front & rear kickplates.

Modular Drawers are F.O.B. Kankakee, Illinois 60901. Customer is responsible for all freight charges from Kankakee, Illinois to destination.

Catalog No. Width Drawers Wt. List Price

Catalog No. Width Drawers Wt. List Price

Cabinets without Drawer Divider Kits

S1000-051	29"	5	315	\$1781.38
E1000-051	43"	5	472	2787.82

Cabinets without Drawer Divider Kits

S1000-061	29"	6	348	\$1901.04
E1000-061	43"	6	521	2996.92

Cabinets with Drawer Divider Kits

SR1000-051	29"	5	377	\$2026.28
ER1000-051	43"	5	566	3228.40

Cabinets with Drawer Divider Kits

SR1000-061	29"	6	413	\$2173.88
ER1000-061	43"	6	619	3469.94

MODULAR DRAWERS

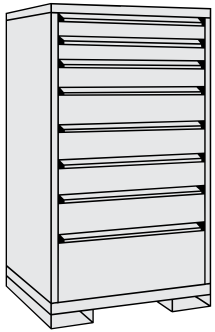

Drawers	Kits*
-80	K4
-80	K4
-100	K3
-120	K1
-120	K1
-140	K1
-240	K8

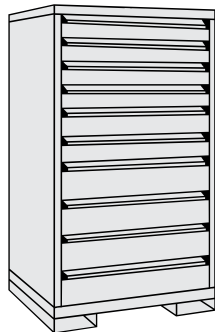

Drawers	Kits*
-80	K4
-80	K4
-80	K4
-80	K4
-100	K3
-100	K3
-120	K1
-120	K1
-120	K1
-120	K1

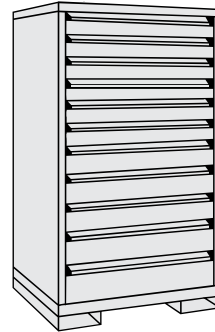

Drawers	Kits*
-80	K4
-80	K4
-80	K4
-80	K4
-80	K4
-80	K4
-100	K3
-100	K3
-100	K3
-100	K3
-120	K1

Catalog No. Width Drawers Wt. List Price

Catalog No. Width Drawers Wt. List Price

Catalog No. Width Drawers Wt. List Price

Cabinets without Drawer Divider Kits

S1000-081	29"	8	411	\$2147.04
E1000-081	43"	8	617	3100.92

Cabinets without Drawer Divider Kits

S1000-101	29"	10	476	\$2415.42
E1000-101	43"	10	714	3832.26

Cabinets without Drawer Divider Kits

S1000-111	29"	11	508	\$2549.62
E1000-111	43"	11	762	4040.26

Cabinets with Drawer Divider Kits

SR1000-081	29"	8	479	\$2468.00
ER1000-081	43"	8	718	3938.48

Cabinets with Drawer Divider Kits

SR1000-101	29"	10	560	\$2851.54
ER1000-101	43"	10	840	4532.28

Cabinets with Drawer Divider Kits

SR1000-111	29"	11	597	\$3017.04
ER1000-111	43"	11	895	4810.72

1360 Series - Preconfigured Cabinets

59-1/4" High x 27-3/4" Deep - Standard Width and Extra Width

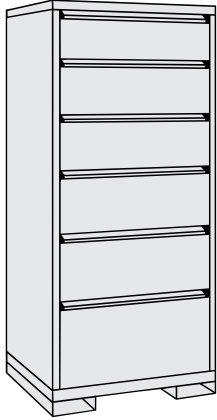

Drawers	Kits*
-180	K5
-200	K5
-200	K5
-240	K8
-240	K8
-300	K8

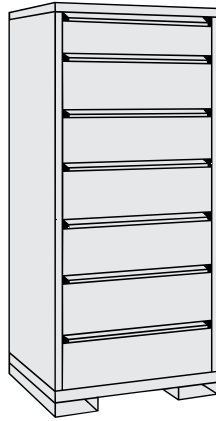

Drawers	Kits*
-160	K1
-200	K5
-200	K5
-200	K5
-200	K5
-200	K5
-200	K5

Specify color when ordering.

Standard Colors:

#065 Industrial Gray, #C386 Red, #B504 Blue, #161 Mist Gray, #445 White, #F604 Pebble and #040 Black

Drawer interiors are #161 Mist Gray.

Notes: *For kit configurations, see pages 29 & 30. Preconfigured units come standard with key lock, fork lift base and front & rear kickplates.

Modular Drawers are F.O.B. Kankakee, Illinois 60901. Customer is responsible for all freight charges from Kankakee, Illinois to destination.

Catalog No. Width Drawers Wt. List Price

Cabinets without Drawer Divider Kits

S1360-061	29"	6	396	\$2116.86
E1360-061	43"	6	594	3265.30

Catalog No. Width Drawers Wt. List Price

Cabinets without Drawer Divider Kits

S1360-071	29"	7	427	\$2281.24
E1360-071	43"	7	641	3548.22

Cabinets with Drawer Divider Kits

SR1360-061	29"	6	458	\$2350.56
ER1360-061	43"	6	687	3686.88

Cabinets with Drawer Divider Kits

SR1360-071	29"	7	511	\$2616.72
ER1360-071	43"	7	767	4146.48

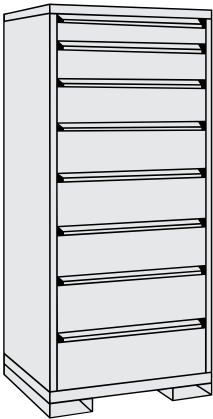

Drawers	Kits*
-120	K1
-140	K1
-160	K1
-180	K5
-180	K5
-180	K5
-200	K5
-200	K5

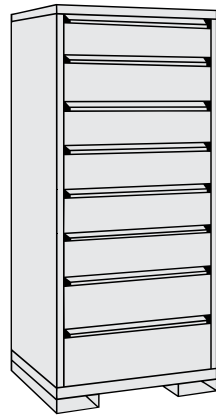

Drawers	Kits*
-160	K1
-160	K1
-160	K1
-160	K1
-160	K1
-160	K1
-200	K5
-200	K5

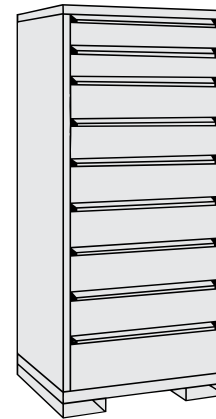

Drawers	Kits*
-120	K1
-120	K1
-140	K1
-140	K1
-160	K1
-160	K1
-160	K1
-160	K1
-200	K5

Catalog No. Width Drawers Wt. List Price

Cabinets without Drawer Divider Kits

S1360-081	29"	8	462	\$2407.60
E1360-081	43"	8	692	3757.32

Catalog No. Width Drawers Wt. List Price

Cabinets without Drawer Divider Kits

S1360-082	29"	8	468	\$2385.24
E1360-082	43"	8	701	3757.32

Catalog No. Width Drawers Wt. List Price

Cabinets without Drawer Divider Kits

S1360-091	29"	9	496	\$2512.72
E1360-091	43"	9	744	3966.44

Cabinets with Drawer Divider Kits

SR1360-081	29"	8	552	\$2777.74
ER1360-081	43"	8	828	4407.04

Cabinets with Drawer Divider Kits

SR1360-082	29"	8	548	\$2735.24
ER1360-082	43"	8	823	4352.24

Cabinets with Drawer Divider Kits

SR1360-091	29"	9	583	\$2896.28
ER1360-091	43"	9	874	4612.80

MODULAR DRAWERS

1360 Series - Preconfigured Cabinets *(continued)*

59-1/4" High x 27-3/4" Deep - Standard Width and Extra Width

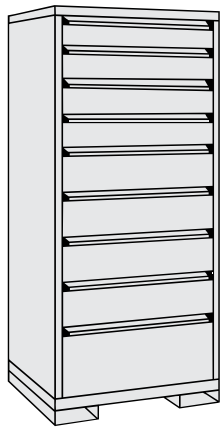

Drawers	Kits*
-120	K1
-120	K1
-120	K1
-120	K1
-160	K1
-160	K1
-160	K1
-160	K1
-240	K8

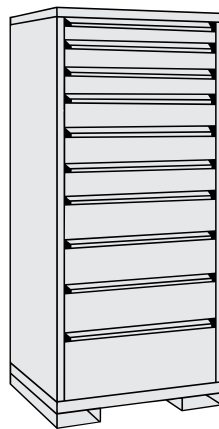

Drawers	Kits*
-80	K4
-100	K3
-100	K3
-120	K1
-120	K1
-120	K1
-160	K1
-160	K1
-160	K1
-240	K8

Specify color when ordering.

Standard Colors:

#065 Industrial Gray, #C386 Red, #B504 Blue,
#161 Mist Gray, #445 White, #F604 Pebble
and #040 Black

Drawer interiors are #161 Mist Gray.

Notes: *For kit configurations, see pages 29 & 30. Preconfigured units come standard with key lock, fork lift base and front & rear kickplates.

Modular Drawers are F.O.B. Kankakee, Illinois 60901. Customer is responsible for all freight charges from Kankakee, Illinois to destination.

Catalog No. Width Drawers Wt. List Price

Catalog No. Width Drawers Wt. List Price

Cabinets without Drawer Divider Kits

S1360-092	29"	9	497	\$2504.88
E1360-092	43"	9	746	3950.80

Cabinets without Drawer Divider Kits

S1360-101	29"	10	529	\$2639.08
E1360-101	43"	10	792	4159.90

Cabinets with Drawer Divider Kits

SR1360-092	29"	9	579	\$2870.56
ER1360-092	43"	9	868	4559.12

Cabinets with Drawer Divider Kits

SR1360-101	29"	10	615	\$2999.16
ER1360-101	43"	10	922	4838.68

MODULAR DRAWERS

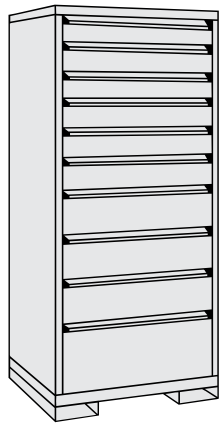

Drawers	Kits*
-100	K3
-100	K3
-100	K3
-100	K3
-120	K1
-120	K1
-160	K1
-160	K1
-160	K1
-240	K8

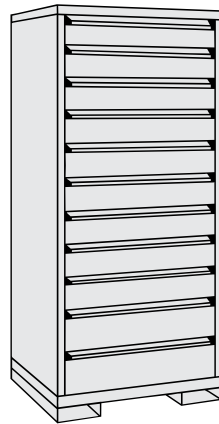

Drawers	Kits*
-120	K1
-120	K1
-120	K1
-120	K1
-120	K1
-120	K1
-120	K1
-120	K1
-120	K1
-140	K1
-140	K1

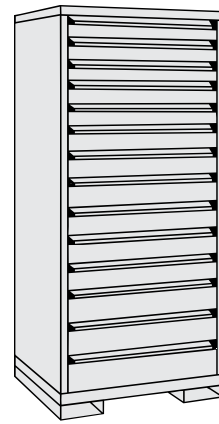

Drawers	Kits*
-80	K4
-80	K4
-80	K4
-80	K4
-80	K4
-80	K4
-100	K3
-100	K3
-100	K3
-100	K3
-100	K3
-100	K3
-100	K3
-120	K1
-120	K1
-120	K1

Catalog No. Width Drawers Wt. List Price

Catalog No. Width Drawers Wt. List Price

Catalog No. Width Drawers Wt. List Price

Cabinets without Drawer Divider Kits

S1360-102	29"	10	527	\$2639.08
E1360-102	43"	10	790	4159.90

Cabinets without Drawer Divider Kits

S1360-111	29"	11	555	\$2773.26
E1360-111	43"	11	833	4383.54

Cabinets without Drawer Divider Kits

S1360-141	29"	14	527	\$3175.84
E1360-141	43"	14	789	5009.76

Cabinets with Drawer Divider Kits

SR1360-102	29"	10	617	\$3060.66
ER1360-102	43"	10	926	4845.40

Cabinets with Drawer Divider Kits

SR1360-111	29"	11	657	\$3237.34
ER1360-111	43"	11	940	5137.24

Cabinets with Drawer Divider Kits

SR1360-141	29"	14	643	\$3771.88
ER1360-141	43"	14	964	5990.48

Standard Drawer Layout & Dimensional Information

Drawer Configurations				
Catalog No.	Height*		Kits*	
	Front	Usable	29" w	43" w
#####-080	3"	2-1/8"	K4	K4E
#####-100	3-7/8"	3"	K3	K3E
#####-120	4-3/4"	3-7/8"	K1	K1E
#####-140	5-1/2"	4-3/4"	K1	K1E
#####-160	6-1/8"	5-1/2"	K1	K1E
#####-180	7"	6-1/8"	K5	K5E
#####-200	7-3/4"	7"	K5	K5E
#####-240	9-1/4"	8-1/2"	K8	K8E
#####-300	11-3/4"	11"	K8	K8E
#####-360	14-1/4"	13-1/2"	K8	K8E

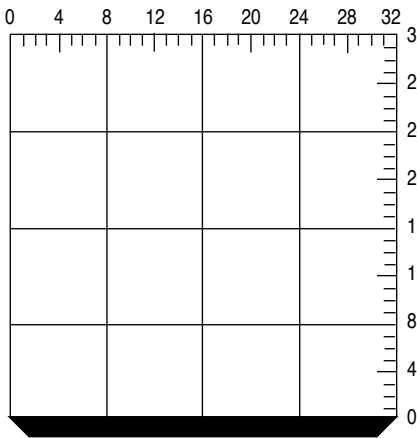

K1
5-7/8" x 6-1/4"
16 Compartments
3 partitions
12 dividers (8u)

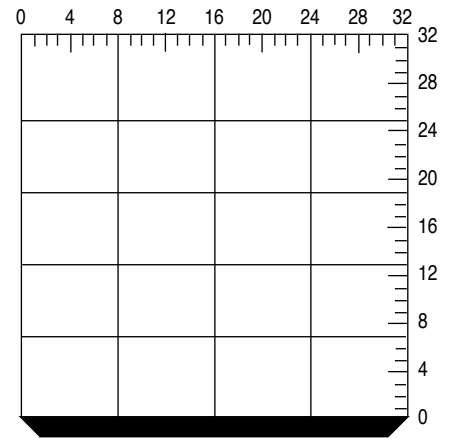

K3
5-7/8" x 4-5/8"
20 Compartments
3 partitions
16 dividers (8u)

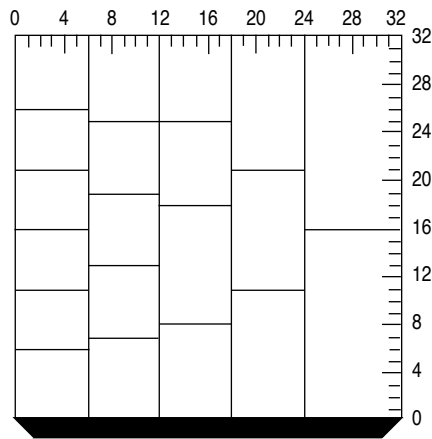

K4
20 Compartments
4 partitions
14 dividers (6u)
1 divider (8u)

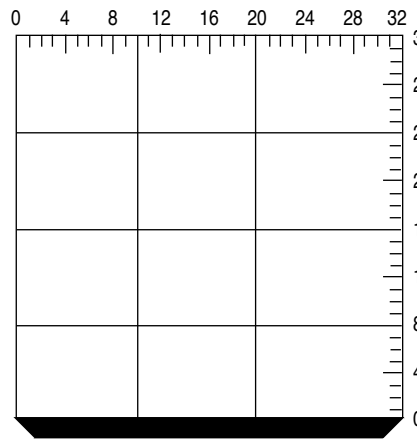

K5
7-3/8" x 6-1/4"
12 Compartments
2 partitions
6 dividers (10u)
3 dividers (12u)

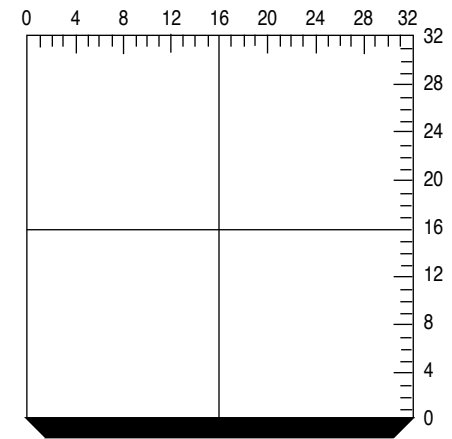

K8
12-1/4" x 12-3/8"
4 Compartments
1 partition
2 dividers (16u)

MODULAR DRAWERS

Extra Wide Drawer Layout & Dimensional Information

Drawer Configurations				
Catalog No.	Height*		Kits*	
	Front	Usable	29" w	43" w
#####-080	3"	2-1/8"	K4	K4E
#####-100	3-7/8"	3"	K3	K3E
#####-120	4-3/4"	3-7/8"	K1	K1E
#####-140	5-1/2"	4-3/4"	K1	K1E
#####-160	6-1/8"	5-1/2"	K1	K1E
#####-180	7"	6-1/8"	K5	K5E
#####-200	7-3/4"	7"	K5	K5E
#####-240	9-1/4"	8-1/2"	K8	K8E
#####-300	11-3/4"	11"	K8	K8E
#####-360	14-1/4"	13-1/2"	K8	K8E

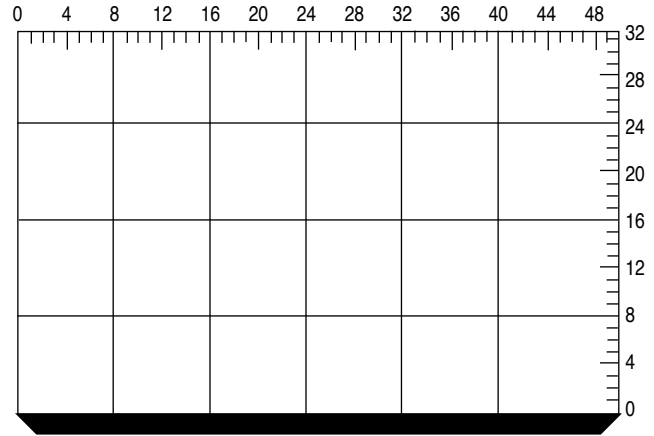

K1E
24 Compartments
 5 partitions
 15 dividers (8u)
 3 dividers (10u)

MODULAR DRAWERS

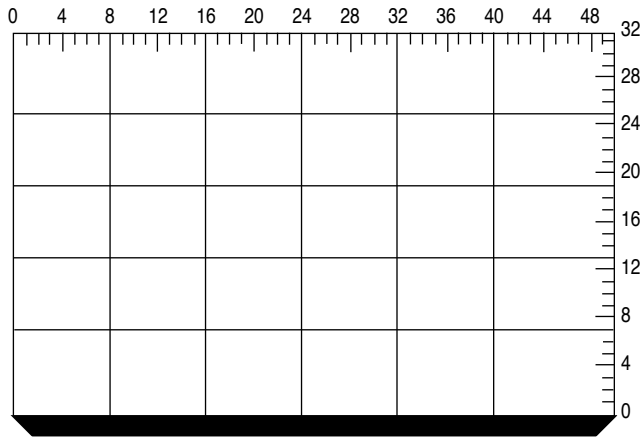

K3E
30 Compartments
 5 partitions
 20 dividers (8u)
 4 dividers (10u)

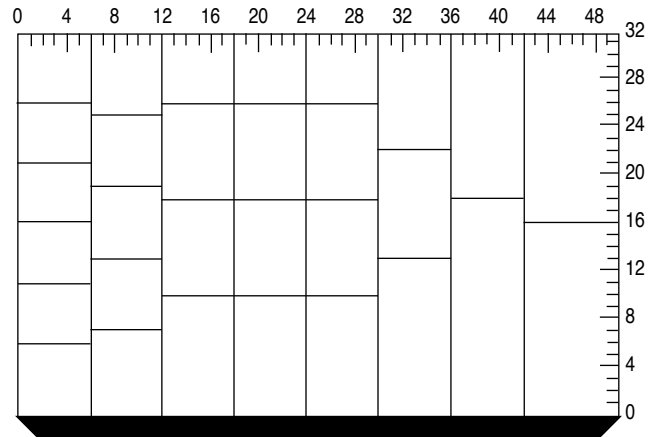

K4E
30 Compartments
 7 partitions
 21 dividers (6u)
 1 divider (8u)

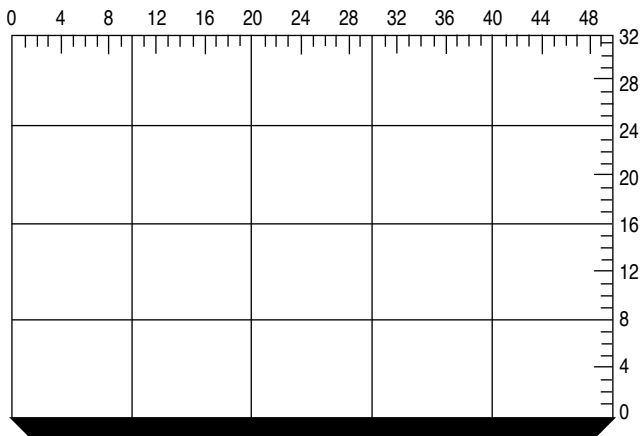

K5E
20 Compartments
 4 partitions
 15 dividers (10u)

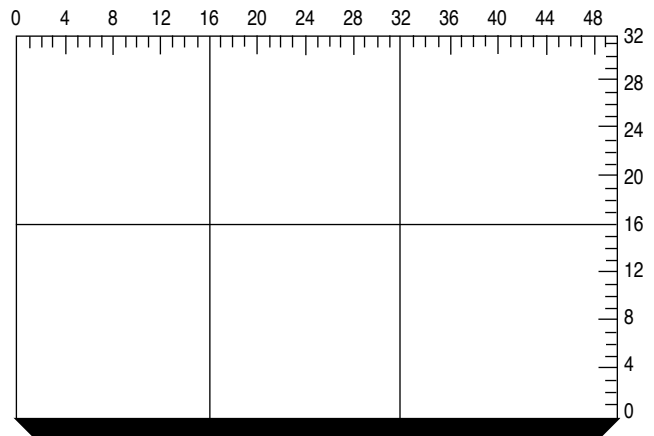

K8E
6 Compartments
 2 partitions
 2 dividers (16u)-1 divider (18u)

For complete loading diagrams of all the drawer layouts available, please consult the **Modular Drawer Layout Guide** - form #673-041-00

Cabinet Housings

All cabinet housings are 27-3/4" deep

Part No.	Points	Description	Cabinet Height	List Price	Weight
Standard Width Cabinet Housings - 29" wide					
19001-300	300	29" x 27" x 15"	15"	\$447.30	52.0
19001-540	540	29" x 27" x 27"	27"	499.88	62.0
19001-600	600	29" x 27" x 30"	30"	514.40	67.0
19001-700	700	29" x 27" x 33-1/2"	33-1/2"	544.60	82.0
19001-800	800	29" x 27" x 37-1/2"	37-1/2"	551.32	85.0
19001-900	900	29" x 27" x 41-1/4"	41-1/4"	566.96	88.0
19001-1000	1000	29" x 27" x 45-1/4"	45-1/4"	596.04	89.0
19001-1200	1200	29" x 27" x 53"	53"	611.70	103.0
19001-1360	1360	29" x 27" x 59-1/4"	59-1/4"	678.80	118.0
19001-1440	1440	29" x 27" x 62-1/2"	62-1/2"	685.50	132.0

Extra Width Cabinet Housings - 43" wide					
19002-300	300	43" x 27" x 15"	15"	\$685.50	115.0
19002-540	540	43" x 27" x 27"	27"	745.88	120.0
19002-600	600	43" x 27" x 30"	30"	760.42	130.0
19002-700	700	43" x 27" x 33-1/2"	33-1/2"	819.70	135.0
19002-800	800	43" x 27" x 37-1/2"	37-1/2"	835.34	139.0
19002-900	900	43" x 27" x 41-1/4"	41-1/4"	849.88	144.0
19002-1000	1000	43" x 27" x 45-1/4"	45-1/4"	894.60	155.0
19002-1200	1200	43" x 27" x 53"	53"	939.34	169.0
19002-1360	1360	43" x 27" x 59-1/4"	59-1/4"	969.54	183.0
19002-1440	1440	43" x 27" x 62-1/2"	62-1/2"	1043.34	197.0

Double Width Cabinet Housings - 58" wide					
19003-300	300	58" x 27" x 15"	15"	\$969.54	173.0
19003-540	540	58" x 27" x 27"	27"	1014.26	182.0
19003-600	600	58" x 27" x 30"	30"	1028.80	188.0
19003-700	700	58" x 27" x 33-1/2"	33-1/2"	1103.72	190.0
19003-800	800	58" x 27" x 37-1/2"	37-1/2"	1118.26	192.0
19003-900	900	58" x 27" x 41-1/4"	41-1/4"	1132.80	195.0
19003-1000	1000	58" x 27" x 45-1/4"	45-1/4"	1177.54	200.0
19003-1200	1200	58" x 27" x 53"	53"	1237.92	210.0
19003-1360	1360	58" x 27" x 59-1/4"	59-1/4"	1297.18	220.0
19003-1440	1440	58" x 27" x 62-1/2"	62-1/2"	1441.44	230.0

Narrow Width Cabinet Housings - 23" wide					
19000-300	300	23" x 27" x 15"	15"	\$417.12	45.0
19000-540	540	23" x 27" x 27"	27"	461.84	50.0
19000-600	600	23" x 27" x 30"	30"	477.50	60.0
19000-700	700	23" x 27" x 33-1/2"	33-1/2"	506.58	70.0
19000-800	800	23" x 27" x 37-1/2"	37-1/2"	522.24	75.0
19000-900	900	23" x 27" x 41-1/4"	41-1/4"	536.76	80.0
19000-1000	1000	23" x 27" x 45-1/4"	45-1/4"	551.32	84.0
19000-1200	1200	23" x 27" x 53"	53"	566.96	92.0
19000-1360	1360	23" x 27" x 59-1/4"	59-1/4"	581.50	100.0
19000-1440	1440	23" x 27" x 62-1/2"	62-1/2"	647.48	108.0

Cabinet Kickplates

Part No.	Description	List Price	Weight
19001-050	Cabinet Kickplate for Standard Width	\$26.84	1.0
19002-050	Cabinet Kickplate for Extra Width	31.28	1.2
19003-050	Cabinet Kickplate for Double Width	44.74	1.5
19000-050	Cabinet Kickplate for Narrow Width	22.38	1.0

Security Locks w/Keys

Part No.	Description	List Price	Weight
19099-300	Security Lock with Two Keys for #300	\$89.46	5.5
19099-540	Security Lock with Two Keys for #540	89.46	6.0
19099-600	Security Lock with Two Keys for #600	89.46	6.5
19099-700	Security Lock with Two Keys for #700	89.46	7.0
19099-800	Security Lock with Two Keys for #800	104.02	7.2
19099-900	Security Lock with Two Keys for #900	104.02	7.5
19099-1000	Security Lock with Two Keys for #1000	104.02	8.0
19099-1200	Security Lock with Two Keys for #1200	104.02	8.2
19099-1360	Security Lock with Two Keys for #1360	119.66	8.5
19099-1440	Security Lock with Two Keys for #1440	119.66	8.7

Cabinet Accessories

Part No.	Description	List Price	Weight
19099-011	Cylinder Lock with Two Keys	\$74.94	0.2
19099-012	Key Blank	8.96	0.1
19099-013	Master Key	44.74	0.1
19099-014	Padlock	44.74	2.0
19099-015	Pendaflex File Drawer	\$111.84	5.0
19099-016	Security Panel	298.58	37.0
19099-018	Slope Top	596.04	50.0
19099-019	Rubber Mat - 30" x 30"	148.74	10.0
19099-020	Hinged Lock Bar	178.92	22.0
19099-021	Shelf Divider - 12" high	\$36.92	2.0
19099-022	Caster Set (two swivel / two rigid)	\$298.58	28.5
19099-023	Aluminum Handle	156.56	10.0
19099-024	Mobile Kit - Caster Set and Handles	451.78	38.5
19099-025	Maple Top - 30" x 30"	327.66	52.0
19099-026	Retainer Top - 30" x 30"	223.66	15.0
19099-027	Cabinet-to-Cabinet Connecting Hardware	\$4.48	0.1
19099-028	Cabinet-to-Floor Connecting Hardware	30.20	2.0
19099-029	Splice Plate Connecting Hardware	44.74	5.0
19099-030	Hi-Lo Kit Connecting Hardware	74.94	5.0
19099-040	Computer Cabinet	\$2161.60	327.5
19099-071	CNC Tool Deck Insert - CAT 50	\$268.38	22.0
19099-072	CNC Tool Deck Insert - CAT 45	268.38	24.0
19099-073	CNC Tool Deck Insert - CAT 40	268.38	24.0
19099-074	CNC Tool Deck Insert - CAT 35	268.38	22.0
19099-075	CNC Tool Deck Insert - CAT 30	268.38	22.0
19099-076	CNC Tool Deck Insert - 1-3/4" std. shank	268.38	22.0
19099-077	CNC Tool Deck Insert - 2" std. shank	268.38	22.0
19099-078	CNC Tool Deck Insert - 2-1/4" std. shank	268.38	22.0
19099-051	CNC Tool Cart w/2 Drws. - 27" x 23" x 36"	\$1640.48	222.5
19099-052	CNC Tool Rack - 29" x 27" x 62"	1193.18	148.5
19099-053	Tool Caddy - 29" x 27" x 54"	1193.18	178.5
19099-054	Additional Tool Caddy Shelf	178.92	25.0

MODULAR DRAWERS

Note:

Modular Drawers Components and Accessories are F.O.B. Kankakee, Illinois 60901. Customer is responsible for all freight charges from Kankakee, Illinois to destination.

18 Ga. Roll-Out Shelves

Part No.	Points	Description	Actual Shelf Width	List Price	Weight
19011-080	80	Standard Width 29" x 24"	29-1/8"	\$238.20	45.0
19012-080	80	Extra Width 43" x 24"	43-1/4"	357.84	62.0
19013-080	80	Double Width 58" x 24"	58-1/4"	447.30	80.0
19010-080	80	Narrow Width 23" x 24"	23-1/4"	223.66	40.0

Modular Drawers

All modular drawers are 24-1/2" deep

Part No.	Points	Description	Front Height	Useable Height	List Price	Wt.
Standard Width Drawers						
19005-080	80	24" x 24" x 3"	3"	2-1/8"	\$164.40	37.0
19005-100	100	24" x 24" x 3-7/8"	3-7/8"	3"	171.10	37.5
19005-120	120	24" x 24" x 4-3/4"	4-3/4"	3-7/8"	178.92	39.0
19005-140	140	24" x 24" x 5-1/2"	5-1/2"	4-3/4"	186.76	39.5
19005-160	160	24" x 24" x 6-1/8"	6-1/8"	5-1/2"	193.48	42.5
19005-180	180	24" x 24" x 7"	7"	6-1/8"	209.12	42.5
19005-200	200	24" x 24" x 7-3/4"	7-3/4"	7"	215.84	43.5
19005-240	240	24" x 24" x 9-1/4"	9-1/4"	8-1/2"	223.66	46.0
19005-300	300	24" x 24" x 11-3/4"	11-3/4"	11"	238.20	49.0
19005-360	360	24" x 24" x 14-1/4"	14-1/4"	13-1/2"	246.02	50.0
19005-400	400	24" x 24" x 15-3/4"	15-3/4"	14-1/2"	253.86	56.0
Extra Width Drawers						
19006-080	80	38" x 24" x 3"	3"	2-1/8"	\$268.38	61.0
19006-100	100	38" x 24" x 3-7/8"	3-7/8"	3"	282.94	64.5
19006-120	120	38" x 24" x 4-3/4"	4-3/4"	3-7/8"	298.58	67.0
19006-140	140	38" x 24" x 5-1/2"	5-1/2"	4-3/4"	313.12	69.0
19006-160	160	38" x 24" x 6-1/8"	6-1/8"	5-1/2"	327.66	71.0
19006-180	180	38" x 24" x 7"	7"	6-1/8"	343.32	73.0
19006-200	200	38" x 24" x 7-3/4"	7-3/4"	7"	357.84	75.0
19006-240	240	38" x 24" x 9-1/4"	9-1/4"	8-1/2"	372.40	77.5
19006-300	300	38" x 24" x 11-3/4"	11-3/4"	11"	388.04	83.0
19006-360	360	38" x 24" x 14-1/4"	14-1/4"	13-1/2"	402.58	86.0
19006-400	400	38" x 24" x 15-3/4"	15-3/4"	14-1/2"	417.12	90.0
Double Width Drawers						
19007-080	80	54" x 24" x 3"	3"	2-1/8"	\$357.84	66.0
19007-100	100	54" x 24" x 3-7/8"	3-7/8"	3"	388.04	68.0
19007-120	120	54" x 24" x 4-3/4"	4-3/4"	3-7/8"	417.12	71.0
19007-140	140	54" x 24" x 5-1/2"	5-1/2"	4-3/4"	447.30	74.0
19007-160	160	54" x 24" x 6-1/8"	6-1/8"	5-1/2"	477.50	77.0
19007-180	180	54" x 24" x 7"	7"	6-1/8"	506.58	80.0
19007-200	200	54" x 24" x 7-3/4"	7-3/4"	7"	536.76	82.0
19007-240	240	54" x 24" x 9-1/4"	9-1/4"	8-1/2"	566.96	85.0
19007-300	300	54" x 24" x 11-3/4"	11-3/4"	11"	596.04	90.0
19007-360	360	54" x 24" x 14-1/4"	14-1/4"	13-1/2"	626.22	96.0
19007-400	400	54" x 24" x 15-3/4"	15-3/4"	14-1/2"	656.42	100.0
Narrow Width Drawers						
19004-080	80	18" x 24" x 3"	3"	2-1/8"	\$148.74	33.0
19004-100	100	18" x 24" x 3-7/8"	3-7/8"	3"	156.56	34.0
19004-120	120	18" x 24" x 4-3/4"	4-3/4"	3-7/8"	164.40	35.0
19004-140	140	18" x 24" x 5-1/2"	5-1/2"	4-3/4"	171.10	37.0
19004-160	160	18" x 24" x 6-1/8"	6-1/8"	5-1/2"	178.92	38.0
19004-180	180	18" x 24" x 7"	7"	6-1/8"	186.76	40.0
19004-200	200	18" x 24" x 7-3/4"	7-3/4"	7"	193.48	41.0
19004-240	240	18" x 24" x 9-1/4"	9-1/4"	8-1/2"	201.30	43.0
19004-300	300	18" x 24" x 11-3/4"	11-3/4"	11"	209.12	45.0
19004-360	360	18" x 24" x 14-1/4"	14-1/4"	13-1/2"	215.84	48.0
19004-400	400	18" x 24" x 15-3/4"	15-3/4"	14-1/2"	223.66	50.0

Note:
Modular Drawer Components are F.O.B. Kankakee, Illinois 60901. Customer is responsible for all freight charges from Kankakee, Illinois to destination.

Cabinet Shelves

Part No.	Points	Description	Shelf Width	List Price	Weight
Standard Width Shelves - 27" x 26"					
19021-C80	80	Center Shelf	27"	\$104.02	22.0
19021-B80	80	Bottom Shelf	27"	104.02	22.0
Extra Width Shelves - 41" x 26"					
19022-C80	80	Center Shelf	41"	\$148.74	37.0
19022-B80	80	Bottom Shelf	41"	148.74	37.0
Double Width Shelves - 56" x 26"					
19023-C80	80	Center Shelf	56"	\$223.66	53.0
19023-B80	80	Bottom Shelf	56"	223.66	53.0
Narrow Width Shelves - 21" x 26"					
19020-C80	80	Center Shelf	21"	\$104.02	20.0
19020-B80	80	Bottom Shelf	21"	104.02	20.0

Dividers

Available in #161 Mist Gray only.

Part No.	Description	Length	Height	List Price	Wt.
3u					
19031-000	3u x 80	2.252"	1.950"	\$0.90	0.1
19031-001	3u x 100	2.252"	3.736"	1.08	0.1
19031-002	3u x 120	2.252"	3.875"	1.14	0.1
4u					
19032-000	4u x 80	3.040"	1.950"	\$0.90	0.1
19032-001	4u x 100	3.040"	3.736"	1.08	0.1
19032-002	4u x 120	3.040"	3.875"	1.26	0.2
5u					
19033-000	5u x 80	3.827"	1.950"	\$1.08	0.1
19033-001	5u x 100	3.827"	3.736"	1.26	0.1
19033-002	5u x 120	3.827"	3.875"	1.38	0.2
6u					
19034-000	6u x 80	4.614"	1.950"	\$1.08	0.1
19034-001	6u x 100	4.614"	3.736"	1.26	0.2
19034-002	6u x 120	4.614"	3.875"	1.44	0.2
19034-003	6u x 180	4.614"	5.899"	2.24	0.2
7u					
19035-000	7u x 80	5.402"	1.950"	\$1.08	0.1
19035-001	7u x 100	5.402"	3.736"	1.26	0.2
19035-002	7u x 120	5.402"	3.875"	1.44	0.3
19035-003	7u x 180	5.402"	5.899"	2.24	0.3
8u					
19036-000	8u x 80	6.189"	1.950"	\$1.22	0.2
19036-001	8u x 100	6.189"	3.736"	1.34	0.2
19036-002	8u x 120	6.189"	3.875"	1.58	0.3
19036-003	8u x 180	6.189"	5.899"	2.42	0.5
19036-004	8u x 240	6.189"	8.200"	3.00	0.7
19036-005	8u x 300	6.189"	10.623"	3.76	0.9
10u					
19037-000	10u x 80	7.764"	1.950"	\$1.34	0.2
19037-001	10u x 100	7.764"	3.736"	1.52	0.3
19037-002	10u x 120	7.764"	3.875"	1.80	0.4
19037-003	10u x 180	7.764"	5.899"	2.68	0.6
19037-004	10u x 240	7.764"	8.200"	3.58	0.9
19037-005	10u x 300	7.764"	10.623"	4.48	1.1

Dividers continued on next page

Dividers *continued* Available in #161 Mist Gray only.

Part No.	Description	Length	Height	List Price	Wt.
12u					
19038-000	12u x 80	9.339"	1.950"	\$1.52	0.3
19038-001	12u x 100	9.339"	3.736"	1.68	0.4
19038-002	12u x 120	9.339"	3.875"	1.96	0.5
19038-003	12u x 180	9.339"	5.899"	3.00	0.8
19038-004	12u x 240	9.339"	8.200"	4.48	1.1
19038-005	12u x 300	9.339"	10.623"	6.00	1.4
16u					
19039-000	16u x 80	12.488"	1.950"	\$1.80	0.3
19039-001	16u x 100	12.488"	3.736"	2.12	0.5
19039-002	16u x 120	12.488"	3.875"	2.42	0.6
19039-003	16u x 180	12.488"	5.899"	4.48	1.0
19039-004	16u x 240	12.488"	8.200"	6.00	1.4
19039-005	16u x 300	12.488"	10.623"	7.48	1.8

Partitions Available in #161 Mist Gray only.

Part No.	Description	Length	Height	List Price	Wt.
Standard Width Partitions					
19021-080	80-P	24.000"	2.000"	\$6.72	1.0
19021-100	100-P	24.000"	3.000"	7.48	1.5
19021-120	120-P	24.000"	3.875"	8.22	2.0
19021-180	180-P	24.000"	6.000"	11.96	2.5
19021-240	240-P	24.000"	8.200"	14.94	3.5
19021-300	300-P	24.000"	10.875"	17.90	4.5
Extra Width Partitions					
19022-080	80-P	38.000"	2.000"	\$22.38	2.0
19022-100	100-P	38.000"	3.000"	25.74	2.5
19022-120	120-P	38.000"	3.875"	30.20	3.0
19022-180	180-P	38.000"	6.000"	36.92	4.5
19022-240	240-P	38.000"	8.200"	44.74	5.5
19022-300	300-P	38.000"	10.875"	52.58	7.0

Dividers & Partitions - Factory Installed Available in #161 Mist Gray only.

Part No.	Length	Height	List Price
Factory Installed Dividers			
19099-DIV	N/A	N/A	\$0.38
Factory Installed Partitions			
19099-PAR	N/A	N/A	\$0.78

Drawer Accessories

Part No.	Description	Width / Length (where applicable)	List Price	Wt.
19027-000	Plastic Groove Tray - Size 2	2-7/8"	\$6.00	0.5
19027-001	Plastic Groove Tray - Size 3	1-7/8"	6.58	0.5
19027-002	Plastic Groove Tray - Size 4	1-3/8"	7.16	0.5
19028-000	Groove Tray Divider - Size 2		\$0.78	0.1
19028-001	Groove Tray Divider - Size 3		0.78	0.1
19028-002	Groove Tray Divider - Size 4		0.78	0.1
19028-003	Groove Tray Label Holders	1-1/8"	\$0.78	0.1
A808A	Plastic Bin - 2-1/2" x 2-1/2" x 2-1/8"		\$1.64	0.1
A808B	Plastic Bin - 2-1/2" x 5" x 2-1/8"		2.46	0.1
N80	Plastic Bin - 6-1/8" x 6-1/8" x 2-1/4"		4.06	0.3
N80-DIV	Plastic Divider - 5-15/16" x 1/16" x 1-15/16"		0.98	0.1
19046-000	Label Holder - 1-1/8"		\$0.90	0.1
19046-001	Label Holder - 1-7/8"		1.22	0.1
CA80A	Conductive Plastic Bin - 2-1/2" x 2-1/2"		\$4.48	0.1
CA80B	Conductive Plastic Bin - 2-1/2" x 5"		5.24	0.1
CN80	Conductive Plastic Bin - 6" x 6"		8.96	0.1
CN80-DIV	Conductive Plastic Divider		2.56	0.1
19050-001	Drawer Liner - Standard Width		\$22.38	0.5
19050-002	Drawer Liner - Extra Width		31.32	0.7
19050-003	Drawer Liner - Double Width		41.40	1.0
19099-1375	Location Pin - 1-3/8"		\$0.90	0.1
19099-1500	Location Pin - 1-1/2"		0.90	0.1
19099-2125	Location Pin - 2-1/8"		0.90	0.1
19099-T001	Tag Pouches		\$3.14	0.1
19099-3005	Drawer Carriage - Standard Width		\$74.94	12.0
19099-3006	Drawer Carriage - Extra Width		89.46	18.0
19099-3007	Drawer Carriage - Double Width		104.02	24.0
19099-3004	Drawer Carriage - Narrow Width		74.94	10.0
19099-RHG	Guide Rail - Right Hand		\$36.92	4.0
19099-LHG	Guide Rail - Left Hand		36.92	4.0
19099-A065	Paper Strip - Standard Width		\$0.78	0.1
19099-A066	Paper Strip - Extra Width		1.14	0.1
19099-A067	Paper Strip - Double Width		1.52	0.2
19099-A064	Paper Strip - Narrow Width		0.78	0.1
19099-B065	Plastic Strip - Standard Width		\$1.52	0.1
19099-B066	Plastic Strip - Extra Width		2.24	0.1
19099-B067	Plastic Strip - Double Width		3.00	0.2
19099-B064	Plastic Strip - Narrow Width		1.52	0.1
19099-RHEC	End Cap - Right Hand		\$1.14	0.1
19099-LHEC	End Cap - Left Hand		1.14	0.1

MODULAR DRAWERS

Note:
Modular Drawer Components and Accessories are F.O.B. Kankakee, Illinois 60901. Customer is responsible for all freight charges from Kankakee, Illinois to destination.

Standard Width Drawer Kits

Part No.	Description	List Price	Wt.
K1 Kits • 16 Compartments			
K1-080	24" x 24" x 3" Drawer w/3 Partitions & 12 Dividers	\$34.44	5.4
K1-100	24" x 24" x 3-7/8" Drawer w/3 Partitions & 12 Dividers	39.68	8.1
K1-120	24" x 24" x 4-3/4" Drawer w/3 Partitions & 12 Dividers	41.92	9.3
K1-180	24" x 24" x 7" Drawer w/3 Partitions & 12 Dividers	64.42	14.7
K1-240	24" x 24" x 9-1/4" Drawer w/3 Partitions & 12 Dividers	80.52	21.3
K1-300	24" x 24" x 11-3/4" Drawer w/3 Partitions & 12 Dividers	98.42	26.7
K2 Kits • 22 Compartments			
K2-080	24" x 24" x 3" Drawer w/2 Partitions & 19 Dividers	\$39.36	7.7
K2-100	24" x 24" x 3-7/8" Drawer w/2 Partitions & 19 Dividers	43.80	10.9
K2-120	24" x 24" x 4-3/4" Drawer w/2 Partitions & 19 Dividers	50.86	12.8
K2-180	24" x 24" x 7" Drawer w/2 Partitions & 19 Dividers	78.72	20.5
K2-240	24" x 24" x 9-1/4" Drawer w/2 Partitions & 19 Dividers	100.52	28.8
K2-300	24" x 24" x 11-3/4" Drawer w/2 Partitions & 19 Dividers	125.24	38.1
K3 Kits • 20 Compartments			
K3-080	24" x 24" x 3" Drawer w/3 Partitions & 16 Dividers	\$39.24	6.2
K3-100	24" x 24" x 3-7/8" Drawer w/3 Partitions & 16 Dividers	45.50	9.3
K3-120	24" x 24" x 4-3/4" Drawer w/3 Partitions & 16 Dividers	48.18	10.9
K3-180	24" x 24" x 7" Drawer w/3 Partitions & 16 Dividers	73.98	17.1
K3-240	24" x 24" x 9-1/4" Drawer w/3 Partitions & 16 Dividers	92.46	24.9
K3-300	24" x 24" x 11-3/4" Drawer w/3 Partitions & 16 Dividers	113.34	31.1
K4 Kits • 20 Compartments			
K4-080	24" x 24" x 3" Drawer w/4 Partitions & 15 Dividers	\$40.58	7.0
K4-100	24" x 24" x 3-7/8" Drawer w/4 Partitions & 15 Dividers	45.80	9.1
K4-120	24" x 24" x 4-3/4" Drawer w/4 Partitions & 15 Dividers	51.92	10.6
K4-180	24" x 24" x 7" Drawer w/4 Partitions & 15 Dividers	82.04	19.2
K5 Kits • 12 Compartments			
K5-080	24" x 24" x 3" Drawer w/2 Partitions & 9 Dividers	\$25.94	4.7
K5-100	24" x 24" x 3-7/8" Drawer w/2 Partitions & 9 Dividers	28.88	6.9
K5-120	24" x 24" x 4-3/4" Drawer w/2 Partitions & 9 Dividers	32.98	7.8
K5-180	24" x 24" x 7" Drawer w/2 Partitions & 9 Dividers	48.94	12.5
K5-240	24" x 24" x 9-1/4" Drawer w/2 Partitions & 9 Dividers	64.74	17.8
K5-300	24" x 24" x 11-3/4" Drawer w/2 Partitions & 9 Dividers	80.52	23.1
K6 Kits • 6 Compartments			
K6-080	24" x 24" x 3" Drawer w/2 Partitions & 3 Dividers	\$17.62	2.9
K6-100	24" x 24" x 3-7/8" Drawer w/2 Partitions & 3 Dividers	19.58	4.3
K6-120	24" x 24" x 4-3/4" Drawer w/2 Partitions & 3 Dividers	21.92	4.6
K6-180	24" x 24" x 7" Drawer w/2 Partitions & 3 Dividers	32.22	7.5
K6-240	24" x 24" x 9-1/4" Drawer w/2 Partitions & 3 Dividers	41.48	10.6
K6-300	24" x 24" x 11-3/4" Drawer w/2 Partitions & 3 Dividers	50.72	13.7
K7 Kits • 25 Compartments			
K7-080	24" x 24" x 3" Drawer w/4 Partitions & 20 Dividers	\$47.74	10.3
K7-100	24" x 24" x 3-7/8" Drawer w/4 Partitions & 20 Dividers	54.90	14.3
K7-120	24" x 24" x 4-3/4" Drawer w/4 Partitions & 20 Dividers	61.46	16.4
K7-180	24" x 24" x 7" Drawer w/4 Partitions & 20 Dividers	92.46	22.4
K8 Kits • 4 Compartments			
K8-080	24" x 24" x 3" Drawer w/1 Partition & 2 Dividers	\$10.30	1.8
K8-100	24" x 24" x 3-7/8" Drawer w/1 Partition & 2 Dividers	11.64	2.7
K8-120	24" x 24" x 4-3/4" Drawer w/1 Partition & 2 Dividers	12.98	3.1
K8-180	24" x 24" x 7" Drawer w/1 Partition & 2 Dividers	20.90	5.1
K8-240	24" x 24" x 9-1/4" Drawer w/1 Partition & 2 Dividers	26.84	7.1
K8-300	24" x 24" x 11-3/4" Drawer w/1 Partition & 2 Dividers	32.82	10.5
K9 Kits • 36 Compartments			
K9-080	24" x 24" x 3" Drawer w/5 Partitions & 30 Dividers	\$64.86	18.0
K9-100	24" x 24" x 3-7/8" Drawer w/5 Partitions & 30 Dividers	74.88	22.0
K9-120	24" x 24" x 4-3/4" Drawer w/5 Partitions & 30 Dividers	83.96	24.5
K10 Kit			
K10-___	50 Compartments & 16 Plastic Bins	\$136.60	14.0
K11 Kit			
K11-___	42 Compartments & 16 Plastic Bins	\$133.30	13.0
K12 Kit			
K12-___	44 Compartments with 16 N80 Bins	\$107.36	5.2

MODULAR DRAWERS

Part No.	Description	List Price	Wt.
K33 Kits • 100 Compartments			
K33-080	24" x 24" x 3" Drawer w/9 Partitions & 90 Dividers	\$140.90	18.0
K33-100	24" x 24" x 3-7/8" Drawer w/9 Partitions & 90 Dividers	161.04	24.3
K33-120	24" x 24" x 4-3/4" Drawer w/9 Partitions & 90 Dividers	176.88	31.5
K34 Kits • 80 Compartments			
K34-080	24" x 24" x 3" Drawer w/9 Partitions & 70 Dividers	\$123.02	16.0
K34-100	24" x 24" x 3-7/8" Drawer w/9 Partitions & 70 Dividers	140.18	21.9
K34-120	24" x 24" x 4-3/4" Drawer w/9 Partitions & 70 Dividers	153.96	27.5
K35 Kits • 60 Compartments			
K35-080	24" x 24" x 3" Drawer w/9 Partitions & 50 Dividers	\$105.12	14.0
K35-100	24" x 24" x 3-7/8" Drawer w/9 Partitions & 50 Dividers	119.30	19.5
K35-120	24" x 24" x 4-3/4" Drawer w/9 Partitions & 50 Dividers	131.06	23.5
K36 Kits • 50 Compartments			
K36-080	24" x 24" x 3" Drawer w/9 Partitions & 40 Dividers	\$96.18	13.0
K36-100	24" x 24" x 3-7/8" Drawer w/9 Partitions & 40 Dividers	108.86	18.3
K36-120	24" x 24" x 4-3/4" Drawer w/9 Partitions & 40 Dividers	119.62	21.5
K38 Kits • 40 Compartments			
K38-080	24" x 24" x 3" Drawer w/9 Partitions & 30 Dividers	\$87.22	12.0
K38-100	24" x 24" x 3-7/8" Drawer w/9 Partitions & 30 Dividers	99.92	17.0
K38-120	24" x 24" x 4-3/4" Drawer w/9 Partitions & 30 Dividers	108.16	19.5
K310 Kits • 30 Compartments			
K310-080	24" x 24" x 3" Drawer w/9 Partitions & 20 Dividers	\$78.28	11.0
K310-100	24" x 24" x 3-7/8" Drawer w/9 Partitions & 20 Dividers	89.46	15.9
K310-120	24" x 24" x 4-3/4" Drawer w/9 Partitions & 20 Dividers	96.70	17.5
K316 Kits • 20 Compartments			
K316-080	24" x 24" x 3" Drawer w/9 Partitions & 10 Dividers	\$69.34	10.0
K316-100	24" x 24" x 3-7/8" Drawer w/9 Partitions & 10 Dividers	79.04	14.7
K316-120	24" x 24" x 4-3/4" Drawer w/9 Partitions & 10 Dividers	85.26	15.5
K332 Kits • 10 Compartments			
K332-080	24" x 24" x 3" Drawer w/9 Partitions	\$60.40	9.0
K332-100	24" x 24" x 3-7/8" Drawer w/9 Partitions	67.10	13.5
K332-120	24" x 24" x 4-3/4" Drawer w/9 Partitions	73.80	18.0
K332-180	24" x 24" x 7" Drawer w/9 Partitions	107.36	22.5
K332-240	24" x 24" x 9-1/4" Drawer w/9 Partitions	134.20	31.5
K332-300	24" x 24" x 11-3/4" Drawer w/9 Partitions	161.04	40.5
K43 Kits • 80 Compartments			
K43-080	24" x 24" x 3" Drawer w/7 Partitions & 72 Dividers	\$111.38	14.2
K43-100	24" x 24" x 3-7/8" Drawer w/7 Partitions & 72 Dividers	127.36	20.9
K43-120	24" x 24" x 4-3/4" Drawer w/7 Partitions & 72 Dividers	147.60	24.9
K44 Kits • 64 Compartments			
K44-080	24" x 24" x 3" Drawer w/7 Partitions & 56 Dividers	\$97.06	12.6
K44-100	24" x 24" x 3-7/8" Drawer w/7 Partitions & 56 Dividers	110.66	18.7
K44-120	24" x 24" x 4-3/4" Drawer w/7 Partitions & 56 Dividers	127.54	21.7
K45 Kits • 48 Compartments			
K45-080	24" x 24" x 3" Drawer w/7 Partitions & 40 Dividers	\$82.76	11.0
K45-100	24" x 24" x 3-7/8" Drawer w/7 Partitions & 40 Dividers	93.94	15.5
K45-120	24" x 24" x 4-3/4" Drawer w/7 Partitions & 40 Dividers	107.52	21.7
K46 Kits • 40 Compartments			
K46-080	24" x 24" x 3" Drawer w/7 Partitions & 32 Dividers	\$75.60	10.2
K46-100	24" x 24" x 3-7/8" Drawer w/7 Partitions & 32 Dividers	85.60	14.0
K46-120	24" x 24" x 4-3/4" Drawer w/7 Partitions & 32 Dividers	97.50	16.9
K48 Kits • 32 Compartments			
K48-080	24" x 24" x 3" Drawer w/7 Partitions & 24 Dividers	\$68.44	9.4
K48-100	24" x 24" x 3-7/8" Drawer w/7 Partitions & 24 Dividers	77.26	12.0
K48-120	24" x 24" x 4-3/4" Drawer w/7 Partitions & 24 Dividers	87.48	15.3

NOTE: For 140 and 160 kits, use 120 kit list price.
 For 200 kit, use 180 kit list price.
 For 360 and higher kits, use 300 kit list price.

Modular Drawer Kits are F.O.B. Kankakee, Illinois 60901. Customer is responsible for all freight charges from Kankakee, Illinois to destination.

Standard Width Drawer Kits

Part No.	Description	List Price	Wt.
K410 Kits • 24 Compartments			
K410-080	24" x 24" x 3" Drawer w/7 Partitions & 16 Dividers	\$61.28	8.6
K410-100	24" x 24" x 3-7/8" Drawer w/7 Partitions & 16 Dividers	68.88	10.0
K410-120	24" x 24" x 4-3/4" Drawer w/7 Partitions & 16 Dividers	77.46	13.7
K416 Kits • 16 Compartments			
K416-080	24" x 24" x 3" Drawer w/7 Partitions & 8 Dividers	\$54.12	7.8
K416-100	24" x 24" x 3-7/8" Drawer w/7 Partitions & 8 Dividers	60.56	9.0
K416-120	24" x 24" x 4-3/4" Drawer w/7 Partitions & 8 Dividers	67.98	12.1
K432 Kits • 8 Compartments			
K432-080	24" x 24" x 3" Drawer w/7 Partitions	\$46.98	7.0
K432-100	24" x 24" x 3-7/8" Drawer w/7 Partitions	52.22	10.5
K432-120	24" x 24" x 4-3/4" Drawer w/7 Partitions	57.42	14.0
K432-180	24" x 24" x 7" Drawer w/7 Partitions	83.52	17.5
K432-240	24" x 24" x 9-1/4" Drawer w/7 Partitions	104.40	24.5
K432-300	24" x 24" x 11-3/4" Drawer w/7 Partitions	125.24	31.5
K440 Kits • 65 Compartments			
K440-080	24" x 24" x 3" Drawer w/7 Partitions & 57 Dividers	\$99.30	13.1
K440-100	24" x 24" x 3-7/8" Drawer w/7 Partitions & 57 Dividers	113.58	19.2
K440-120	24" x 24" x 4-3/4" Drawer w/7 Partitions & 57 Dividers	126.50	22.3
K53 Kits • 60 Compartments			
K53-080	24" x 24" x 3" Drawer w/5 Partitions & 54 Dividers	\$89.92	12.2
K53-100	24" x 24" x 3-7/8" Drawer w/5 Partitions & 54 Dividers	104.92	18.3
K53-120	24" x 24" x 4-3/4" Drawer w/5 Partitions & 54 Dividers	124.22	20.1
K54 Kits • 48 Compartments			
K54-080	24" x 24" x 3" Drawer w/5 Partitions & 42 Dividers	\$77.38	10.6
K54-100	24" x 24" x 3-7/8" Drawer w/5 Partitions & 42 Dividers	89.90	15.9
K54-120	24" x 24" x 4-3/4" Drawer w/5 Partitions & 42 Dividers	107.60	17.3
K55 Kits • 63 Compartments			
K55-080	24" x 24" x 3" Drawer w/5 Partitions & 30 Dividers	\$64.86	9.0
K55-100	24" x 24" x 3-7/8" Drawer w/5 Partitions & 30 Dividers	74.88	13.5
K55-120	24" x 24" x 4-3/4" Drawer w/5 Partitions & 30 Dividers	83.96	14.5
K56 Kits • 30 Compartments			
K56-080	24" x 24" x 3" Drawer w/5 Partitions & 24 Dividers	\$58.20	8.2
K56-100	24" x 24" x 3-7/8" Drawer w/5 Partitions & 24 Dividers	67.36	12.3
K56-120	24" x 24" x 4-3/4" Drawer w/5 Partitions & 24 Dividers	77.12	13.1
K58 Kits • 24 Compartments			
K58-080	24" x 24" x 3" Drawer w/5 Partitions & 18 Dividers	\$51.94	7.4
K58-100	24" x 24" x 3-7/8" Drawer w/5 Partitions & 18 Dividers	59.84	11.1
K58-120	24" x 24" x 4-3/4" Drawer w/5 Partitions & 18 Dividers	68.76	11.7
K510 Kits • 18 Compartments			
K510-080	24" x 24" x 3" Drawer w/5 Partitions & 12 Dividers	\$45.68	6.6
K510-100	24" x 24" x 3-7/8" Drawer w/5 Partitions & 12 Dividers	52.32	9.9
K510-120	24" x 24" x 4-3/4" Drawer w/5 Partitions & 12 Dividers	60.40	10.3
K516 Kits • 12 Compartments			
K516-080	24" x 24" x 3" Drawer w/5 Partitions & 6 Dividers	\$39.12	5.8
K516-100	24" x 24" x 3-7/8" Drawer w/5 Partitions & 6 Dividers	44.80	8.7
K516-120	24" x 24" x 4-3/4" Drawer w/5 Partitions & 6 Dividers	52.06	8.9
K532 Kits • 6 Compartments			
K532-080	24" x 24" x 3" Drawer w/5 Partitions	\$33.56	5.0
K532-100	24" x 24" x 3-7/8" Drawer w/5 Partitions	37.30	7.0
K532-120	24" x 24" x 4-3/4" Drawer w/5 Partitions	41.02	7.5
K532-180	24" x 24" x 7" Drawer w/5 Partitions	59.88	12.5
K532-240	24" x 24" x 9-1/4" Drawer w/5 Partitions	74.58	17.5
K532-300	24" x 24" x 11-3/4" Drawer w/5 Partitions	89.46	22.5
K540 Kits • 43 Compartments			
K540-080	24" x 24" x 3" Drawer w/5 Partitions & 37 Dividers	\$69.50	9.9
K540-100	24" x 24" x 3-7/8" Drawer w/5 Partitions & 37 Dividers	79.88	14.7
K540-120	24" x 24" x 4-3/4" Drawer w/5 Partitions & 37 Dividers	92.20	16.8

Part No.	Description	List Price	Wt.
K541 Kits • 18 Compartments			
K541-080	24" x 24" x 3" Drawer w/5 Partitions & 12 Dividers	\$44.02	6.8
K541-100	24" x 24" x 3-7/8" Drawer w/5 Partitions & 12 Dividers	50.54	10.1
K541-120	24" x 24" x 4-3/4" Drawer w/5 Partitions & 12 Dividers	57.30	10.9
K63 Kits • 50 Compartments			
K63-080	24" x 24" x 3" Drawer w/4 Partitions & 45 Dividers	\$73.80	13.0
K63-100	24" x 24" x 3-7/8" Drawer w/4 Partitions & 45 Dividers	86.20	16.8
K63-120	24" x 24" x 4-3/4" Drawer w/4 Partitions & 45 Dividers	97.24	21.3
K64 Kits • 40 Compartments			
K64-080	24" x 24" x 3" Drawer w/4 Partitions & 35 Dividers	\$63.40	11.0
K64-100	24" x 24" x 3-7/8" Drawer w/4 Partitions & 35 Dividers	73.68	14.4
K64-120	24" x 24" x 4-3/4" Drawer w/4 Partitions & 35 Dividers	82.92	17.9
K65 Kits • 30 Compartments			
K65-080	24" x 24" x 3" Drawer w/4 Partitions & 25 Dividers	\$52.96	9.0
K65-100	24" x 24" x 3-7/8" Drawer w/4 Partitions & 25 Dividers	61.16	12.0
K65-120	24" x 24" x 4-3/4" Drawer w/4 Partitions & 25 Dividers	68.62	14.5
K66 Kits • 25 Compartments			
K66-080	24" x 24" x 3" Drawer w/4 Partitions & 20 Dividers	\$48.64	8.0
K66-100	24" x 24" x 3-7/8" Drawer w/4 Partitions & 20 Dividers	54.90	10.3
K66-120	24" x 24" x 4-3/4" Drawer w/4 Partitions & 20 Dividers	61.46	12.8
K68 Kits • 20 Compartments			
K68-080	24" x 24" x 3" Drawer w/4 Partitions & 15 Dividers	\$43.40	7.0
K68-100	24" x 24" x 3-7/8" Drawer w/4 Partitions & 15 Dividers	48.64	9.6
K68-120	24" x 24" x 4-3/4" Drawer w/4 Partitions & 15 Dividers	54.30	11.1
K610 Kits • 15 Compartments			
K610-080	24" x 24" x 3" Drawer w/4 Partitions & 10 Dividers	\$38.20	6.0
K610-100	24" x 24" x 3-7/8" Drawer w/4 Partitions & 10 Dividers	41.48	8.4
K610-120	24" x 24" x 4-3/4" Drawer w/4 Partitions & 10 Dividers	47.14	9.0
K616 Kits • 10 Compartments			
K616-080	24" x 24" x 3" Drawer w/4 Partitions & 5 Dividers	\$32.98	5.5
K616-100	24" x 24" x 3-7/8" Drawer w/4 Partitions & 5 Dividers	35.22	7.2
K616-120	24" x 24" x 4-3/4" Drawer w/4 Partitions & 5 Dividers	39.98	7.7
K632 Kits • 5 Compartments			
K632-080	24" x 24" x 3" Drawer w/4 Partitions	\$26.84	4.0
K632-100	24" x 24" x 3-7/8" Drawer w/4 Partitions	29.84	6.0
K632-120	24" x 24" x 4-3/4" Drawer w/4 Partitions	32.82	7.0
K632-180	24" x 24" x 7" Drawer w/4 Partitions	47.74	10.0
K632-240	24" x 24" x 9-1/4" Drawer w/4 Partitions	59.66	14.0
K632-300	24" x 24" x 11-3/4" Drawer w/4 Partitions	71.58	18.0
K640 Kits • 28 Compartments			
K640-080	24" x 24" x 3" Drawer w/4 Partitions & 23 Dividers	\$49.82	7.4
K640-100	24" x 24" x 3-7/8" Drawer w/4 Partitions & 23 Dividers	56.46	11.3
K640-120	24" x 24" x 4-3/4" Drawer w/4 Partitions & 23 Dividers	64.36	12.2
K641 Kits • 25 Compartments			
K641-080	24" x 24" x 3" Drawer w/4 Partitions & 20 Dividers	\$48.18	7.5
K641-100	24" x 24" x 3-7/8" Drawer w/4 Partitions & 20 Dividers	55.18	10.7
K641-120	24" x 24" x 4-3/4" Drawer w/4 Partitions & 20 Dividers	61.56	12.2
K642 Kits • 20 Compartments			
K642-080	24" x 24" x 3" Drawer w/4 Partitions & 15 Dividers	\$42.94	7.0
K642-100	24" x 24" x 3-7/8" Drawer w/4 Partitions & 15 Dividers	48.90	9.3
K642-120	24" x 24" x 4-3/4" Drawer w/4 Partitions & 15 Dividers	54.70	10.8
K643 Kits • 40 Compartments			
K643-080	24" x 24" x 3" Drawer w/4 Partitions & 35 Dividers	\$64.42	10.3
K643-100	24" x 24" x 3-7/8" Drawer w/4 Partitions & 35 Dividers	73.88	15.1
K643-120	24" x 24" x 4-3/4" Drawer w/4 Partitions & 35 Dividers	83.74	17.3

MODULAR DRAWERS

NOTE: For 140 and 160 kits, use 120 kit list price.
 For 200 kit, use 180 kit list price.
 For 360 and higher kits, use 300 kit list price.

Modular Drawer Kits are F.O.B. Kankakee, Illinois 60901. Customer is responsible for all freight charges from Kankakee, Illinois to destination.

Standard Width Drawer Kits

Part No.	Description	List Price	Wt.
K740 Kits • 60 Compartments			
K740-080	24" x 24" x 3" Drawer w/6 Partitions & 53 Dividers	\$92.32	11.8
K740-100	24" x 24" x 3-7/8" Drawer w/6 Partitions & 53 Dividers	105.92	17.4
K740-120	24" x 24" x 4-3/4" Drawer w/6 Partitions & 53 Dividers	117.24	20.6
K83 Kits • 40 Compartments			
K83-080	24" x 24" x 3" Drawer w/3 Partitions & 36 Dividers	\$63.08	10.2
K83-100	24" x 24" x 3-7/8" Drawer w/3 Partitions & 36 Dividers	70.68	15.3
K83-120	24" x 24" x 4-3/4" Drawer w/3 Partitions & 36 Dividers	80.96	18.9
K83-180	24" x 24" x 7" Drawer w/3 Partitions & 36 Dividers	121.68	29.1
K83-240	24" x 24" x 9-1/4" Drawer w/3 Partitions & 36 Dividers	152.08	42.9
K83-300	24" x 24" x 11-3/4" Drawer w/3 Partitions & 36 Dividers	187.88	53.1
K84 Kits • 32 Compartments			
K84-080	24" x 24" x 3" Drawer w/3 Partitions & 28 Dividers	\$53.56	8.6
K84-100	24" x 24" x 3-7/8" Drawer w/3 Partitions & 28 Dividers	59.94	12.9
K84-120	24" x 24" x 4-3/4" Drawer w/3 Partitions & 28 Dividers	68.44	15.7
K84-180	24" x 24" x 7" Drawer w/3 Partitions & 28 Dividers	102.60	24.3
K84-240	24" x 24" x 9-1/4" Drawer w/3 Partitions & 28 Dividers	128.26	35.7
K84-300	24" x 24" x 11-3/4" Drawer w/3 Partitions & 28 Dividers	158.08	44.3
K85 Kits • 24 Compartments			
K85-080	24" x 24" x 3" Drawer w/3 Partitions & 20 Dividers	\$44.02	7.0
K85-100	24" x 24" x 3-7/8" Drawer w/3 Partitions & 20 Dividers	49.20	10.5
K85-120	24" x 24" x 4-3/4" Drawer w/3 Partitions & 20 Dividers	55.92	12.5
K85-180	24" x 24" x 7" Drawer w/3 Partitions & 20 Dividers	84.42	19.5
K85-240	24" x 24" x 9-1/4" Drawer w/3 Partitions & 20 Dividers	104.40	28.5
K85-300	24" x 24" x 11-3/4" Drawer w/3 Partitions & 20 Dividers	128.26	35.5
K86 Kits • 20 Compartments			
K86-080	24" x 24" x 3" Drawer w/3 Partitions & 16 Dividers	\$39.24	6.2
K86-100	24" x 24" x 3-7/8" Drawer w/3 Partitions & 16 Dividers	43.84	9.3
K86-120	24" x 24" x 4-3/4" Drawer w/3 Partitions & 16 Dividers	49.66	10.9
K86-180	24" x 24" x 7" Drawer w/3 Partitions & 16 Dividers	74.88	17.1
K86-240	24" x 24" x 9-1/4" Drawer w/3 Partitions & 16 Dividers	92.46	24.9
K86-300	24" x 24" x 11-3/4" Drawer w/3 Partitions & 16 Dividers	113.34	31.1
K88 Kits • 16 Compartments			
K88-080	24" x 24" x 3" Drawer w/3 Partitions & 12 Dividers	\$34.44	5.4
K88-100	24" x 24" x 3-7/8" Drawer w/3 Partitions & 12 Dividers	39.68	8.1
K88-120	24" x 24" x 4-3/4" Drawer w/3 Partitions & 12 Dividers	41.92	9.3
K88-180	24" x 24" x 7" Drawer w/3 Partitions & 12 Dividers	64.42	14.7
K88-240	24" x 24" x 9-1/4" Drawer w/3 Partitions & 12 Dividers	80.52	21.3
K88-300	24" x 24" x 11-3/4" Drawer w/3 Partitions & 12 Dividers	98.42	26.7
K810 Kits • 12 Compartments			
K810-080	24" x 24" x 3" Drawer w/3 Partitions & 8 Dividers	\$29.70	4.6
K810-100	24" x 24" x 3-7/8" Drawer w/3 Partitions & 8 Dividers	34.32	6.9
K810-120	24" x 24" x 4-3/4" Drawer w/3 Partitions & 8 Dividers	37.14	7.7
K810-180	24" x 24" x 7" Drawer w/3 Partitions & 8 Dividers	54.90	12.3
K810-240	24" x 24" x 9-1/4" Drawer w/3 Partitions & 8 Dividers	68.62	17.7
K810-300	24" x 24" x 11-3/4" Drawer w/3 Partitions & 8 Dividers	83.52	22.3
K816 Kits • 8 Compartments			
K816-080	24" x 24" x 3" Drawer w/3 Partitions & 4 Dividers	\$24.92	3.8
K816-100	24" x 24" x 3-7/8" Drawer w/3 Partitions & 4 Dividers	28.96	5.7
K816-120	24" x 24" x 4-3/4" Drawer w/3 Partitions & 4 Dividers	30.86	6.1
K816-180	24" x 24" x 7" Drawer w/3 Partitions & 4 Dividers	45.36	9.9
K816-240	24" x 24" x 9-1/4" Drawer w/3 Partitions & 4 Dividers	56.68	14.1
K816-300	24" x 24" x 11-3/4" Drawer w/3 Partitions & 4 Dividers	68.62	17.9
K832 Kits • 4 Compartments			
K832-080	24" x 24" x 3" Drawer w/3 Partitions	\$20.14	3.0
K832-100	24" x 24" x 3-7/8" Drawer w/3 Partitions	22.38	4.5
K832-120	24" x 24" x 4-3/4" Drawer w/3 Partitions	26.12	4.5
K832-180	24" x 24" x 7" Drawer w/3 Partitions	35.78	7.5
K832-240	24" x 24" x 9-1/4" Drawer w/3 Partitions	44.74	10.5
K832-300	24" x 24" x 11-3/4" Drawer w/3 Partitions	53.68	13.5

Part No.	Description	List Price	Wt.
K840 Kits • 19 Compartments			
K840-080	24" x 24" x 3" Drawer w/3 Partitions & 15 Dividers	\$36.24	4.7
K840-100	24" x 24" x 3-7/8" Drawer w/3 Partitions & 15 Dividers	41.02	8.5
K840-120	24" x 24" x 4-3/4" Drawer w/3 Partitions & 15 Dividers	46.56	9.3
K841 Kits • 24 Compartments			
K841-080	24" x 24" x 3" Drawer w/3 Partitions & 20 Dividers	\$43.26	7.5
K841-100	24" x 24" x 3-7/8" Drawer w/3 Partitions & 20 Dividers	49.08	11.0
K841-120	24" x 24" x 4-3/4" Drawer w/3 Partitions & 20 Dividers	55.70	13.0
K842 Kits • 24 Compartments			
K842-080	24" x 24" x 3" Drawer w/3 Partitions & 20 Dividers	\$44.02	7.0
K842-100	24" x 24" x 3-7/8" Drawer w/3 Partitions & 20 Dividers	49.98	11.0
K842-120	24" x 24" x 4-3/4" Drawer w/3 Partitions & 20 Dividers	56.16	12.5
K843 Kits • 13 Compartments			
K843-080	24" x 24" x 3" Drawer w/3 Partitions & 9 Dividers	\$29.70	4.4
K843-100	24" x 24" x 3-7/8" Drawer w/3 Partitions & 9 Dividers	33.42	6.9
K843-120	24" x 24" x 4-3/4" Drawer w/3 Partitions & 9 Dividers	37.64	7.3
K103 Kits • 30 Compartments			
K103-080	24" x 24" x 3" Drawer w/2 Partitions & 27 Dividers	\$51.00	10.1
K103-100	24" x 24" x 3-7/8" Drawer w/2 Partitions & 27 Dividers	56.80	14.7
K103-120	24" x 24" x 4-3/4" Drawer w/2 Partitions & 27 Dividers	66.08	17.4
K103-180	24" x 24" x 7" Drawer w/2 Partitions & 27 Dividers	99.02	27.1
K103-240	24" x 24" x 9-1/4" Drawer w/2 Partitions & 27 Dividers	134.52	39.1
K103-300	24" x 24" x 11-3/4" Drawer w/2 Partitions & 27 Dividers	169.98	51.3
K104 Kits • 24 Compartments			
K104-080	24" x 24" x 3" Drawer w/2 Partitions & 21 Dividers	\$42.66	8.3
K104-100	24" x 24" x 3-7/8" Drawer w/2 Partitions & 21 Dividers	47.48	12.1
K104-120	24" x 24" x 4-3/4" Drawer w/2 Partitions & 21 Dividers	55.02	14.2
K104-180	24" x 24" x 7" Drawer w/2 Partitions & 21 Dividers	82.30	22.5
K104-240	24" x 24" x 9-1/4" Drawer w/2 Partitions & 21 Dividers	111.26	32.2
K104-300	24" x 24" x 11-3/4" Drawer w/2 Partitions & 21 Dividers	140.18	41.9
K105 Kits • 18 Compartments			
K105-080	24" x 24" x 3" Drawer w/2 Partitions & 15 Dividers	\$34.32	6.5
K105-100	24" x 24" x 3-7/8" Drawer w/2 Partitions & 15 Dividers	38.20	9.5
K105-120	24" x 24" x 4-3/4" Drawer w/2 Partitions & 15 Dividers	44.02	11.1
K105-180	24" x 24" x 7" Drawer w/2 Partitions & 15 Dividers	65.64	17.5
K105-240	24" x 24" x 9-1/4" Drawer w/2 Partitions & 15 Dividers	88.00	25.0
K105-300	24" x 24" x 11-3/4" Drawer w/2 Partitions & 15 Dividers	110.36	32.1
K106 Kits • 15 Compartments			
K106-080	24" x 24" x 3" Drawer w/2 Partitions & 12 Dividers	\$31.48	5.6
K106-100	24" x 24" x 3-7/8" Drawer w/2 Partitions & 12 Dividers	33.54	8.2
K106-120	24" x 24" x 4-3/4" Drawer w/2 Partitions & 12 Dividers	38.48	9.4
K106-180	24" x 24" x 7" Drawer w/2 Partitions & 12 Dividers	57.26	15.0
K106-240	24" x 24" x 9-1/4" Drawer w/2 Partitions & 12 Dividers	76.36	21.4
K106-300	24" x 24" x 11-3/4" Drawer w/2 Partitions & 12 Dividers	95.46	27.8
K108 Kits • 12 Compartments			
K108-080	24" x 24" x 3" Drawer w/2 Partitions & 9 Dividers	\$25.94	4.7
K108-100	24" x 24" x 3-7/8" Drawer w/2 Partitions & 9 Dividers	28.88	6.9
K108-120	24" x 24" x 4-3/4" Drawer w/2 Partitions & 9 Dividers	32.98	7.8
K108-180	24" x 24" x 7" Drawer w/2 Partitions & 9 Dividers	48.94	12.5
K108-240	24" x 24" x 9-1/4" Drawer w/2 Partitions & 9 Dividers	64.74	17.8
K108-300	24" x 24" x 11-3/4" Drawer w/2 Partitions & 9 Dividers	80.52	23.1
K1010 Kits • 9 Compartments			
K1010-080	24" x 24" x 3" Drawer w/2 Partitions & 6 Dividers	\$21.80	3.8
K1010-100	24" x 24" x 3-7/8" Drawer w/2 Partitions & 6 Dividers	24.22	5.6
K1010-120	24" x 24" x 4-3/4" Drawer w/2 Partitions & 6 Dividers	27.46	6.2
K1010-180	24" x 24" x 7" Drawer w/2 Partitions & 6 Dividers	40.58	10.0
K1010-240	24" x 24" x 9-1/4" Drawer w/2 Partitions & 6 Dividers	53.10	14.2
K1010-300	24" x 24" x 11-3/4" Drawer w/2 Partitions & 6 Dividers	65.64	18.4

NOTE: For 140 and 160 kits, use 120 kit list price.
For 200 kit, use 180 kit list price.
For 360 and higher kits, use 300 kit list price.

Modular Drawer Kits are F.O.B. Kankakee, Illinois 60901. Customer is responsible for all freight charges from Kankakee, Illinois to destination.

Standard Width Drawer Kits

Part No.	Description	List Price	Wt.
K1016 Kits • 6 Compartments			
K1016-080	24" x 24" x 3" Drawer w/2 Partitions & 3 Dividers	\$17.62	2.9
K1016-100	24" x 24" x 3-7/8" Drawer w/2 Partitions & 3 Dividers	19.58	4.3
K1016-120	24" x 24" x 4-3/4" Drawer w/2 Partitions & 3 Dividers	21.92	4.6
K1016-180	24" x 24" x 7" Drawer w/2 Partitions & 3 Dividers	32.22	7.5
K1016-240	24" x 24" x 9-1/4" Drawer w/2 Partitions & 3 Dividers	41.48	10.6
K1016-300	24" x 24" x 11-3/4" Drawer w/2 Partitions & 3 Dividers	50.72	13.7
K1032 Kits • 3 Compartments			
K1032-080	24" x 24" x 3" Drawer w/2 Partitions	\$13.42	2.0
K1032-100	24" x 24" x 3-7/8" Drawer w/2 Partitions	14.94	3.0
K1032-120	24" x 24" x 4-3/4" Drawer w/2 Partitions	16.42	3.0
K1032-180	24" x 24" x 7" Drawer w/2 Partitions	23.88	5.0
K1032-240	24" x 24" x 9-1/4" Drawer w/2 Partitions	29.84	7.0
K1032-300	24" x 24" x 11-3/4" Drawer w/2 Partitions	35.78	9.0
K1040 Kits • 11 Compartments			
K1040-080	24" x 24" x 3" Drawer w/2 Partitions & 8 Dividers	\$23.44	4.1
K1040-100	24" x 24" x 3-7/8" Drawer w/2 Partitions & 8 Dividers	26.48	5.6
K1040-120	24" x 24" x 4-3/4" Drawer w/2 Partitions & 8 Dividers	30.42	6.5
K1041 Kits • 12 Compartments			
K1041-080	24" x 24" x 3" Drawer w/2 Partitions & 9 Dividers	\$25.94	4.7
K1041-100	24" x 24" x 3-7/8" Drawer w/2 Partitions & 9 Dividers	28.88	6.9
K1041-120	24" x 24" x 4-3/4" Drawer w/2 Partitions & 9 Dividers	32.98	7.8
K1041-180	24" x 24" x 7" Drawer w/2 Partitions & 9 Dividers	48.94	12.5
K1041-240	24" x 24" x 9-1/4" Drawer w/2 Partitions & 9 Dividers	64.74	17.8
K1041-300	24" x 24" x 11-3/4" Drawer w/2 Partitions & 9 Dividers	80.52	23.1
K1042 Kits • 9 Compartments			
K1042-080	24" x 24" x 3" Drawer w/2 Partitions & 6 Dividers	\$21.80	3.6
K1042-100	24" x 24" x 3-7/8" Drawer w/2 Partitions & 6 Dividers	24.48	5.4
K1042-120	24" x 24" x 4-3/4" Drawer w/2 Partitions & 6 Dividers	27.46	6.2
K1042-180	24" x 24" x 7" Drawer w/2 Partitions & 6 Dividers	42.38	10.0
K1042-240	24" x 24" x 9-1/4" Drawer w/2 Partitions & 6 Dividers	53.68	14.2
K1042-300	24" x 24" x 11-3/4" Drawer w/2 Partitions & 6 Dividers	65.64	19.4
K163 Kits • 20 Compartments			
K163-080	24" x 24" x 3" Drawer w/1 Partition & 18 Dividers	\$38.92	8.2
K163-100	24" x 24" x 3-7/8" Drawer w/1 Partition & 18 Dividers	45.06	12.3
K163-120	24" x 24" x 4-3/4" Drawer w/1 Partition & 18 Dividers	51.16	15.9
K163-180	24" x 24" x 7" Drawer w/1 Partition & 18 Dividers	92.46	25.9
K163-240	24" x 24" x 9-1/4" Drawer w/1 Partition & 18 Dividers	122.28	35.9
K163-300	24" x 24" x 11-3/4" Drawer w/1 Partition & 18 Dividers	152.08	58.5
K164 Kits • 16 Compartments			
K164-080	24" x 24" x 3" Drawer w/1 Partition & 14 Dividers	\$31.76	6.6
K164-100	24" x 24" x 3-7/8" Drawer w/1 Partition & 14 Dividers	36.68	9.9
K164-120	24" x 24" x 4-3/4" Drawer w/1 Partition & 14 Dividers	41.60	12.7
K164-180	24" x 24" x 7" Drawer w/1 Partition & 14 Dividers	74.58	20.7
K164-240	24" x 24" x 9-1/4" Drawer w/1 Partition & 14 Dividers	98.42	28.7
K164-300	24" x 24" x 11-3/4" Drawer w/1 Partition & 14 Dividers	122.28	46.5
K165 Kits • 12 Compartments			
K165-080	24" x 24" x 3" Drawer w/1 Partition & 10 Dividers	\$24.60	5.0
K165-100	24" x 24" x 3-7/8" Drawer w/1 Partition & 10 Dividers	28.36	7.5
K165-120	24" x 24" x 4-3/4" Drawer w/1 Partition & 10 Dividers	32.08	9.5
K165-180	24" x 24" x 7" Drawer w/1 Partition & 10 Dividers	56.68	15.5
K165-240	24" x 24" x 9-1/4" Drawer w/1 Partition & 10 Dividers	74.58	21.5
K165-300	24" x 24" x 11-3/4" Drawer w/1 Partition & 10 Dividers	92.46	34.5
K166 Kits • 10 Compartments			
K166-080	24" x 24" x 3" Drawer w/1 Partition & 8 Dividers	\$21.02	4.2
K166-100	24" x 24" x 3-7/8" Drawer w/1 Partition & 8 Dividers	24.16	6.3
K166-120	24" x 24" x 4-3/4" Drawer w/1 Partition & 8 Dividers	27.30	7.9
K166-180	24" x 24" x 7" Drawer w/1 Partition & 8 Dividers	47.74	12.9
K166-240	24" x 24" x 9-1/4" Drawer w/1 Partition & 8 Dividers	62.62	17.9
K166-300	24" x 24" x 11-3/4" Drawer w/1 Partition & 8 Dividers	77.56	28.5

Part No.	Description	List Price	Wt.
K168 Kits • 8 Compartments			
K168-080	24" x 24" x 3" Drawer w/1 Partition & 6 Dividers	\$17.44	3.4
K168-100	24" x 24" x 3-7/8" Drawer w/1 Partition & 6 Dividers	20.00	5.1
K168-120	24" x 24" x 4-3/4" Drawer w/1 Partition & 6 Dividers	22.54	6.3
K168-180	24" x 24" x 7" Drawer w/1 Partition & 6 Dividers	38.80	10.3
K168-240	24" x 24" x 9-1/4" Drawer w/1 Partition & 6 Dividers	50.72	14.3
K168-300	24" x 24" x 11-3/4" Drawer w/1 Partition & 6 Dividers	62.62	22.5
K1610 Kits • 6 Compartments			
K1610-080	24" x 24" x 3" Drawer w/1 Partition & 4 Dividers	\$13.88	2.6
K1610-100	24" x 24" x 3-7/8" Drawer w/1 Partition & 4 Dividers	15.84	3.9
K1610-120	24" x 24" x 4-3/4" Drawer w/1 Partition & 4 Dividers	17.76	4.7
K1610-180	24" x 24" x 7" Drawer w/1 Partition & 4 Dividers	29.84	7.7
K1610-240	24" x 24" x 9-1/4" Drawer w/1 Partition & 4 Dividers	38.80	10.7
K1610-300	24" x 24" x 11-3/4" Drawer w/1 Partition & 4 Dividers	47.74	16.5
K1616 Kits • 4 Compartments			
K1616-080	24" x 24" x 3" Drawer w/1 Partition & 2 Dividers	\$10.30	1.8
K1616-100	24" x 24" x 3-7/8" Drawer w/1 Partition & 2 Dividers	11.64	2.7
K1616-120	24" x 24" x 4-3/4" Drawer w/1 Partition & 2 Dividers	12.98	3.1
K1616-180	24" x 24" x 7" Drawer w/1 Partition & 2 Dividers	20.90	5.1
K1616-240	24" x 24" x 9-1/4" Drawer w/1 Partition & 2 Dividers	26.84	7.1
K1616-300	24" x 24" x 11-3/4" Drawer w/1 Partition & 2 Dividers	32.82	10.5
K1632 Kits • 2 Compartments			
K1632-080	24" x 24" x 3" Drawer w/1 Partition	\$6.72	1.0
K1632-100	24" x 24" x 3-7/8" Drawer w/1 Partition	7.48	1.5
K1632-120	24" x 24" x 4-3/4" Drawer w/1 Partition	8.22	1.8
K1632-180	24" x 24" x 7" Drawer w/1 Partition	11.96	2.5
K1632-240	24" x 24" x 9-1/4" Drawer w/1 Partition	14.94	3.5
K1632-300	24" x 24" x 11-3/4" Drawer w/1 Partition	17.90	4.5

MODULAR DRAWERS

NOTE: For 140 and 160 kits, use 120 kit list price.
 For 200 kit, use 180 kit list price.
 For 360 and higher kits, use 300 kit list price.

Modular Drawer Kits are F.O.B. Kankakee, Illinois 60901. Customer is responsible for all freight charges from Kankakee, Illinois to destination.

Extra Width Drawer Kits

Part No.	Description	List Price	Wt.
K1E Kits • 24 Compartments			
1E-080	38" x 24" x 3" Drawer w/5 Partitions & 18 Dividers	\$55.48	8.1
1E-100	38" x 24" x 3-7/8" Drawer w/5 Partitions & 18 Dividers	61.90	12.2
1E-120	38" x 24" x 4-3/4" Drawer w/5 Partitions & 18 Dividers	69.86	14.0
1E-180	38" x 24" x 7" Drawer w/5 Partitions & 18 Dividers	103.50	22.1
1E-240	38" x 24" x 9-1/4" Drawer w/5 Partitions & 18 Dividers	130.04	32.0
1E-300	38" x 24" x 11-3/4" Drawer w/5 Partitions & 18 Dividers	158.80	40.1
K2E Kits • 40 Compartments			
2E-080	38" x 24" x 3" Drawer w/4 Partitions & 35 Dividers	\$73.80	11.6
2E-100	38" x 24" x 3-7/8" Drawer w/4 Partitions & 35 Dividers	82.04	16.4
2E-120	38" x 24" x 4-3/4" Drawer w/4 Partitions & 35 Dividers	95.46	19.2
2E-180	38" x 24" x 7" Drawer w/4 Partitions & 35 Dividers	141.68	30.8
2E-240	38" x 24" x 9-1/4" Drawer w/4 Partitions & 35 Dividers	184.92	43.2
2E-300	38" x 24" x 11-3/4" Drawer w/4 Partitions & 35 Dividers	228.12	57.2
K3E Kits • 30 Compartments			
3E-080	38" x 24" x 3" Drawer w/5 Partitions & 24 Dividers	\$62.80	9.3
3E-100	38" x 24" x 3-7/8" Drawer w/5 Partitions & 24 Dividers	70.10	14.0
3E-120	38" x 24" x 4-3/4" Drawer w/5 Partitions & 24 Dividers	79.50	16.4
3E-180	38" x 24" x 7" Drawer w/5 Partitions & 24 Dividers	118.10	25.7
3E-240	38" x 24" x 9-1/4" Drawer w/5 Partitions & 24 Dividers	148.50	37.4
3E-300	38" x 24" x 11-3/4" Drawer w/5 Partitions & 24 Dividers	181.92	46.7
K4E Kits • 30 Compartments			
4E-080	38" x 24" x 3" Drawer w/7 Partitions & 22 Dividers	\$70.10	10.5
4E-100	38" x 24" x 3-7/8" Drawer w/7 Partitions & 22 Dividers	79.86	13.7
4E-120	38" x 24" x 4-3/4" Drawer w/7 Partitions & 22 Dividers	88.76	15.9
4E-180	38" x 24" x 7" Drawer w/7 Partitions & 22 Dividers	132.86	28.8
4E-240	38" x 24" x 9-1/4" Drawer w/7 Partitions & 22 Dividers	169.98	41.9
4E-300	38" x 24" x 11-3/4" Drawer w/7 Partitions & 22 Dividers	207.28	52.4
K5E Kits • 15 Compartments			
5E-080	38" x 24" x 3" Drawer w/4 Partitions & 15 Dividers	\$46.98	7.1
5E-100	38" x 24" x 3-7/8" Drawer w/4 Partitions & 15 Dividers	52.40	10.4
5E-120	38" x 24" x 4-3/4" Drawer w/4 Partitions & 15 Dividers	59.66	11.7
5E-180	38" x 24" x 7" Drawer w/4 Partitions & 15 Dividers	88.00	18.8
5E-240	38" x 24" x 9-1/4" Drawer w/4 Partitions & 15 Dividers	113.34	26.7
5E-300	38" x 24" x 11-3/4" Drawer w/4 Partitions & 15 Dividers	138.66	34.7
K6E Kits • 10 Compartments			
6E-080	38" x 24" x 3" Drawer w/4 Partitions & 5 Dividers	\$33.56	4.4
6E-100	38" x 24" x 3-7/8" Drawer w/4 Partitions & 5 Dividers	37.30	6.5
6E-120	38" x 24" x 4-3/4" Drawer w/4 Partitions & 5 Dividers	41.78	6.9
6E-180	38" x 24" x 7" Drawer w/4 Partitions & 5 Dividers	61.16	11.3
6E-240	38" x 24" x 9-1/4" Drawer w/4 Partitions & 5 Dividers	77.56	15.9
6E-300	38" x 24" x 11-3/4" Drawer w/4 Partitions & 5 Dividers	93.94	20.6
K7E Kits • 40 Compartments			
7E-080	38" x 24" x 3" Drawer w/7 Partitions & 32 Dividers	\$80.40	15.5
7E-100	38" x 24" x 3-7/8" Drawer w/7 Partitions & 32 Dividers	92.30	21.5
7E-120	38" x 24" x 4-3/4" Drawer w/7 Partitions & 32 Dividers	103.22	24.6
7E-180	38" x 24" x 7" Drawer w/7 Partitions & 32 Dividers	155.10	33.6
7E-240	38" x 24" x 9-1/4" Drawer w/7 Partitions & 32 Dividers	199.82	48.9
7E-300	38" x 24" x 11-3/4" Drawer w/7 Partitions & 32 Dividers	268.38	61.1
K8E Kits • 6 Compartments			
8E-080	38" x 24" x 3" Drawer w/2 Partitions & 3 Dividers	\$19.12	2.7
8E-100	38" x 24" x 3-7/8" Drawer w/2 Partitions & 3 Dividers	21.48	4.1
8E-120	38" x 24" x 4-3/4" Drawer w/2 Partitions & 3 Dividers	25.68	4.7
8E-180	38" x 24" x 7" Drawer w/2 Partitions & 3 Dividers	38.78	7.7
8E-240	38" x 24" x 9-1/4" Drawer w/2 Partitions & 3 Dividers	49.20	10.7
8E-300	38" x 24" x 11-3/4" Drawer w/2 Partitions & 3 Dividers	58.92	15.8
K9E Kits • 60 Compartments			
9E-080	38" x 24" x 3" Drawer w/9 Partitions & 50 Dividers	\$112.60	27.0
9E-100	38" x 24" x 3-7/8" Drawer w/9 Partitions & 50 Dividers	129.72	33.0
9E-120	38" x 24" x 4-3/4" Drawer w/9 Partitions & 50 Dividers	142.42	36.8
9E-180	38" x 24" x 7" Drawer w/9 Partitions & 50 Dividers	219.18	55.1
9E-240	38" x 24" x 9-1/4" Drawer w/9 Partitions & 50 Dividers	283.32	80.2
9E-300	38" x 24" x 11-3/4" Drawer w/9 Partitions & 50 Dividers	347.42	100.2

MODULAR DRAWERS

Cabinet Accessories

business organization systems

Part No.	Description	List Price	Weight
19099-051	CNC Tool Cart w/2 Drws. - 27" x 23" x 36"	\$1640.48	222.5
19099-052	CNC Tool Rack - 29" x 27" x 62"	1193.18	148.5
19099-053	Tool Caddy - 29" x 27" x 54"	1193.18	178.5
19099-054	Additional Tool Caddy Shelf	178.92	25.0
19099-040	Computer Cabinet	\$2161.60	327.5

Risers, Shelves & Accessories

Part No.	Description	List Price	Weight
19090-MU48	48" Worksurface Mounting Upright Set	\$119.66	30.0
19090-MU_*	Custom Worksurface Mounting Upright Set	119.66	30.0
19090-WU39	48" Wall Mount Upright Set	74.94	10.0
19090-HB30	30" Brace	\$44.74	2.0
19090-HB36	36" Brace	52.58	2.5
19090-HB48	48" Brace	59.28	3.0
19090-HD30	30" x 12" HD Straight Shelf - 14 ga.	\$104.02	25.0
19090-HD36	36" x 12" HD Straight Shelf - 14 ga.	111.84	30.0
19090-HD48	48" x 12" HD Straight Shelf - 14 ga.	148.74	35.0
19090-LB30	30" Light Supports	\$148.74	20.0
19090-LB36	36" Light Supports	148.40	22.0
19090-LB48	48" Light Supports	178.92	25.0
19090-CNC3	CNC Tool Shelf - Any Taper	\$178.92	25.0

*specify size required.

Modular Drawer Kits and Accessories are F.O.B. Kankakee, Illinois 60901. Customer is responsible for all freight charges from Kankakee, Illinois to destination.

Notes

SOUTHWEST **SOLUTIONS** GROUP

business organization systems

NOTES

RIVET-SPAN® Units

Bulk Storage Units

7'0"/84" High

Extra Beam Levels

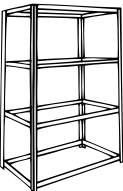
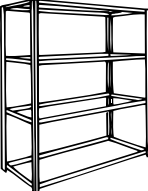
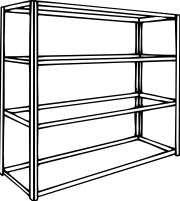
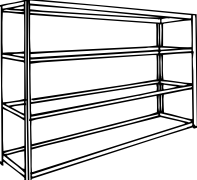
Unit Width	Starter Unit Catalog No.	List Price	Adder Unit Catalog No.	List Price	Unit Depth	Capacity Per Beam Level****	Beam Type	Wt.	Catalog No.	List Price
48" Wide 4 Beam Levels 	•B4818DR47	\$155.14	•A4818DR47	\$145.12	18"	730 lbs.	Angle	59.2	•BL4818DR	\$26.46
	•B4824DR47	161.30	•A4824DR47	151.28	24"	730 lbs.	Angle	62.4	•BL4824DR	28.02
	•B4830DR47	168.54	•A4830DR47	158.54	30"	730 lbs.	Angle	65.6	•BL4830DR	29.82
	•B4836DR47	178.32	•A4836DR47	168.34	36"	730 lbs.	Angle	68.8	•BL4836DR	32.28
	•B4848DR47	194.52	•A4848DR47	184.50	48"	730 lbs.	Angle	76.0	•BL4848DR	36.30
60" Wide 4 Beam Levels 	•B6018DR47	\$172.82	•A6018DR47	\$162.78	18"	680 lbs.	Angle	65.6	•BL6018DR	\$30.90
	•B6018DH47	193.88	•A6018DH47	183.86		1300 lbs.	*Angle	72.4	•BL6018DH*	36.16
	B6018CH47	215.58	A6018CH47	205.60		*2250 lbs.	*Channel**	98.0	BL6018CH*	43.40
	•B6024DR47	178.96	•A6024DR47	168.96	24"	680 lbs.	Angle	68.8	•BL6024DR	32.44
	•B6024DH47	203.46	•A6024DH47	193.46		*1300 lbs.	*Angle	77.6	•BL6024DH*	38.54
	B6024CH47	225.18	A6024CH47	215.16		*2250 lbs.	*Channel**	103.2	BL6024CH*	45.80
	•B6030DR47	186.20	•A6030DR47	176.20	30"	680 lbs.	Angle	72.0	•BL6030DR	34.26
	•B6030DH47	213.26	•A6030DH47	203.24		*1300 lbs.	*Angle	82.8	•BL6030DH*	41.00
	B6030CH47	234.98	A6030CH47	224.96		*2250 lbs.	*Channel**	108.4	BL6030CH*	48.24
	•B6036DR47	195.98	•A6036DR47	186.00	36"	680 lbs.	Angle	75.2	•BL6036DR	36.68
	•B6036DH47	227.08	•A6036DH47	217.10		*1300 lbs.	*Angle	88.0	•BL6036DH*	44.48
	B6036CH47	248.78	A6036CH47	238.80		*2250 lbs.	*Channel**	113.6	BL6036CH*	51.70
	•B6048DR47	212.20	•A6048DR47	202.16	48"	680 lbs.	Angle	82.4	•BL6048DR	40.74
	•B6048DH47	251.68	•A6048DH47	241.68		*1300 lbs.	*Angle	99.2	•BL6048DH*	50.60
B6048CH47	273.40	A6048CH47	263.38		*2250 lbs.	*Channel**	124.8	BL6048CH*	57.86	
72" Wide 4 Beam Levels 	•B7218DR47	\$188.34	•A7218DR47	\$178.32	18"	450 lbs.	Angle	72.8	•BL7218DR	\$34.76
	•B7218DH47	209.40	•A7218DH47	199.42		*1050 lbs.	*Angle	79.6	•BL7218DH*	40.04
	•B7218CH47	235.28	•A7218CH47	225.28		*1700 lbs.	*Channel**	109.2	•BL7218CH*	48.68
	•B7224DR47	194.54	•A7224DR47	184.50	24"	450 lbs.	Angle	76.0	•BL7224DR	36.30
	•B7224DH47	219.02	•A7224DH47	208.98		*1050 lbs.	*Angle	84.8	•BL7224DH*	42.44
	•B7224CH47	244.86	•A7224CH47	234.86		*1700 lbs.	*Channel**	114.4	•BL7224CH*	51.06
	•B7230DR47	201.74	•A7230DR47	191.74	30"	450 lbs.	Angle	79.2	•BL7230DR	38.12
	•B7230DH47	228.78	•A7230DH47	218.78		*1050 lbs.	*Angle	90.0	•BL7230DH*	44.90
	•B7230CH47	254.66	•A7230CH47	244.66		*1700 lbs.	*Channel**	119.6	•BL7230CH*	53.52
	•B7236DR47	211.54	•A7236DR47	201.54	36"	450 lbs.	Angle	82.4	•BL7236DR	40.58
	•B7236DH47	242.64	•A7236DH47	232.62		*1050 lbs.	*Angle	95.2	•BL7236DH*	48.34
	•B7236CH47	268.52	•A7236CH47	258.50		*1700 lbs.	*Channel**	117.4	•BL7236CH*	56.98
	•B7248DR47	227.72	•A7248DR47	217.72	48"	450 lbs.	Angle	89.6	•BL7248DR	44.62
	•B7248DH47	267.24	•A7248DH47	257.20		*1050 lbs.	*Angle	106.4	•BL7248DH*	54.50
•B7248CH47	293.12	•A7248CH47	283.08		*1700 lbs.	*Channel**	128.8	•BL7248CH*	63.12	
96" Wide 4 Beam Levels 	•B9618DH47	\$265.62	•A9618DH47	\$255.62	18"	*650 lbs.	*Angle	100.0	•BL9618DH*	\$54.08
	•B9618CH47	298.36	•A9618CH47	288.36		*1300 lbs.	*Channel**	130.0	•BL9618CH	65.02
	•B9624DH47	278.60	•A9624DH47	268.62	24"	*650 lbs.	*Angle	107.7	•BL9624DH*	57.34
	•B9624CH47	311.34	•A9624CH47	301.34		*1300 lbs.	*Channel**	137.2	•BL9624CH	68.26
	•B9630DH47	290.96	•A9630DH47	280.96	30"	*650 lbs.	*Angle	114.4	•BL9630DH*	60.44
	•B9630CH47	323.70	•A9630CH47	313.72		*1300 lbs.	*Channel**	144.4	•BL9630CH	71.34
	•B9636DH47	308.86	•A9636DH47	298.84	36"	*650 lbs.	*Angle	121.6	•BL9636DH*	70.02
	•B9636CH47	341.60	•A9636CH47	331.58		*1300 lbs.	*Channel**	151.6	•BL9636CH	75.82
	•B9648DH47	341.88	•A9648DH47	331.84	48"	*650 lbs.	*Angle	136.8	•BL9648DH*	73.14
	•B9648CH47	374.58	•A9648CH47	364.58		*1300 lbs.	*Channel**	166.8	•BL9648CH	84.06

All units include metal framing only.
Decking material must be ordered separately. See Page 43.

*Includes (1) support tie per level except 96" which has (2) support ties.

**Units with channel beams have angle beams with support ties located directly at the floor level.

***Capacities are for steel beams only with evenly distributed loads and do not reflect the capacity of the decking material.

All units shipped K.D.

PART NUMBERING SYSTEMS PRECONFIGURED CATALOG UNITS

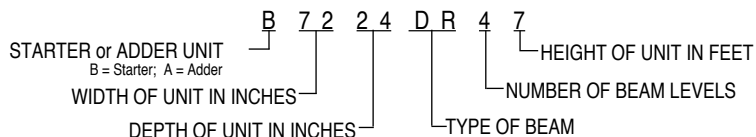

SR = Single Rivet Beams
LP = Double Rivet Low Profile Beams
DR = Double Rivet Angle Beams



ZB = Double Rivet Z Beams
DH = Double Rivet Angle Beams with Support Tie
CH = Double Rivet Channel Beams with Support Tie

RIVET-SPAN® Units

Single Rivet Shelf Units*

7'0"/84" High



Extra Shelf Levels**

Unit Width	Starter Units Catalog No.	List Price	Adder Units Catalog No.	List Price	Unit Depth	Capacity Per Beam Level***	Wt.	Catalog No.	List Price
36" Wide 6 Shelf Levels 	B3612SR67	\$126.54	A3612SR67	\$116.54	12"	350 lbs.	48.2	BL3612SR	\$7.94
	•B3618SR67	131.54	•A3618SR67	121.54	18"	350 lbs.	50.2	•BL3618SR	7.94
	•B3624SR67	135.38	•A3624SR67	125.38	24"	350 lbs.	52.4	•BL3624SR	7.94
	•B3636SR67	169.16	•A3636SR67	159.16	36"	350 lbs.	65.8	•BL3636SR	15.88
42" Wide 6 Shelf Levels 	B4212SR67	\$135.28	A4212SR67	\$125.24	12"	260 lbs.	51.4	BL4212SR	\$9.18
	B4218SR67	140.28	A4218SR67	130.26	18"	260 lbs.	53.4	BL4218SR	9.18
	B4224SR67	144.10	A4224SR67	134.08	24"	260 lbs.	55.6	BL4224SR	9.18
	B4236SR67	177.92	A4236SR67	167.92	36"	260 lbs.	68.8	BL4236SR	17.08
48" Wide 6 Shelf Levels 	B4812SR67	\$142.72	A4812SR67	\$132.72	12"	240 lbs.	55.8	BL4812SR	\$9.98
	•B4818SR67	147.74	•A4818SR67	137.70	18"	240 lbs.	57.8	•BL4818SR	9.98
	•B4824SR67	151.56	•A4824SR67	141.56	24"	240 lbs.	60.0	•BL4824SR	9.98
	•B4836SR67	185.36	•A4836SR67	175.34	36"	240 lbs.	73.2	•BL4836SR	17.90

Double Rivet Low Profile Shelf Units*

7'0"/84" High

Extra Shelf Levels**

Unit Width	Starter Units Catalog No.	List Price	Adder Units Catalog No.	List Price	Unit Depth	Capacity Per Beam Level***	Wt.	Catalog No.	List Price
36" Wide 7 Shelf Levels 	B3612LP77	\$153.36	A3612LP77	\$143.38	12"	450 lbs.	54.2	BL3612LP	\$11.72
	B3618LP77	158.38	A3618LP77	148.36	18"	450 lbs.	56.2	BL3618LP	11.72
	B3624LP77	162.20	A3624LP77	152.22	24"	450 lbs.	58.4	BL3624LP	11.72
	B3636LP77	203.94	A3636LP77	193.94	36"	450 lbs.	74.6	BL3636LP	19.64
42" Wide 7 Shelf Levels 	B4212LP77	\$168.10	A4212LP77	\$158.12	12"	430 lbs.	57.8	BL4212LP	\$13.90
	B4218LP77	173.12	A4218LP77	163.12	18"	430 lbs.	59.8	BL4218LP	13.90
	B4224LP77	176.94	A4224LP77	166.94	24"	430 lbs.	63.0	BL4224LP	13.90
	B4236LP77	218.68	A4236LP77	208.68	36"	430 lbs.	78.2	BL4236LP	21.84
48" Wide 7 Shelf Levels 	B4812LP77	\$179.28	A4812LP77	\$169.30	12"	400 lbs.	64.8	BL4812LP	\$15.28
	B4818LP77	184.30	A4818LP77	174.28	18"	400 lbs.	66.8	BL4818LP	15.28
	B4824LP77	188.12	A4824LP77	178.12	24"	400 lbs.	69.0	BL4824LP	15.28
	B4836LP77	229.86	A4836LP77	219.86	36"	400 lbs.	85.2	BL4836LP	23.22

All units include metal framing only.
Decking material must be ordered separately. See Page 43.

*All units include double rivet angle beams, left-to-right and front-to-back, at the top and bottom beam levels.

***Capacities are for steel beams only with evenly distributed loads and do not reflect the capacity of the decking material.

Shelf units 24" deep or less include only (2) intermediate front-to-back single rivet beams. Units 30" or deeper include front-to-back single rivet beams at every intermediate beam level.

All units shipped K.D.

Important:

Wall, floor or top tie anchoring is recommended for units when the height to depth ratio exceeds 4.

Example: A 7'/84" high x 18" deep unit has a height to depth ratio of 4.67 and should be attached to a firm restraint, such as a floor, wall or tied overhead across the aisle to an opposite upright assembly.

**Extra shelf levels 24" deep or less include left-to-right beams only. Extra shelf levels 30" or deeper also include front-to-back single rivet beams.

Beam Profiles

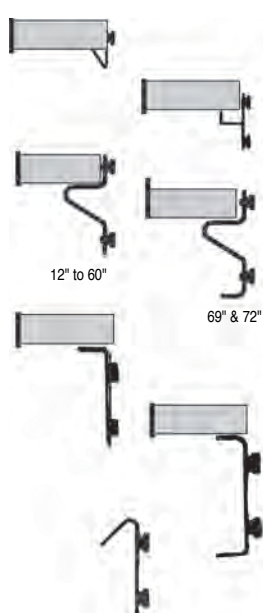









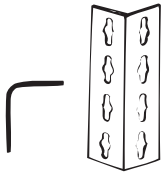
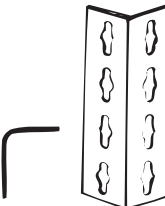

- Single Rivet Beam**
Shelving - standard duty
- Double Rivet Low Profile Beam**
Shelving - heavy duty
- Double Rivet Z Beam**
Shelving - heavy duty
Bulk Storage - standard duty
- Double Rivet Angle Beam**
Bulk Storage - standard duty
- Double Rivet Channel Beam**
Bulk Storage - heavy duty
- Tire Beam**
Tires and Wheels - standard duty

12" to 60" 69" & 72"

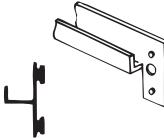
RIVET-SPAN®

RIVET-SPAN® Components

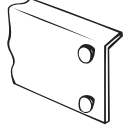
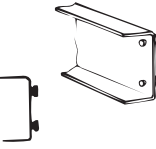
Catalog No.	Size	Wt. Each	Qty. Per Pack	List Price	
Angle Post					
	•10061-000	6'0"/72"	4.1	8	\$10.60
	•10061-001	7'0"/84"	4.8	8	12.34
	•10061-002	8'0"/96"	5.5	8	14.08
	•10061-003	9'0"/108"	6.2	8	15.80
	•10061-004	10'0"/120"	6.9	8	18.18
	•10061-006	12'0"/144"	8.3	8	22.38
1.57" x 1.57", 14 gauge, punched on 1-1/2" centers					
Heavy Duty Angle Post					
	10060-000	6'0"/72"	4.7	8	\$12.92
	10060-001	7'0"/84"	5.4	8	15.06
	10060-002	8'0"/96"	6.2	8	17.24
	10060-003	9'0"/108"	7.0	8	19.40
	10060-004	10'0"/120"	7.8	8	22.22
	10060-006	12'0"/144"	9.3	8	27.06
	10060-008	14'0"/168"	10.9	4	31.56
	10060-009	15'0"/180"	11.6	4	33.82
	10060-010	16'0"/192"	12.4	4	36.12
1-7/8" x 1-7/8", 14 gauge, punched on 1-1/2" centers					
Tie Plate - Angle Post					
	•10066-000	-	.2	50	\$2.18
14 gauge					
Post Splicer - Angle Post					
	10065-000	-	.4	50	\$6.26
13 gauge					
T Post					
	•10132-000	6'0"/72"	8.3	4	\$17.02
	•10132-001	7'0"/84"	9.6	4	19.64
	•10132-002	8'0"/96"	11.0	4	22.22
	•10132-003	9'0"/108"	12.4	4	25.10
	•10132-004	10'0"/120"	13.8	4	27.82
	•10132-006	12'0"/144"	16.5	4	33.98
3.34" x 1.57", 14 gauge, punched on 1-1/2" centers					
Post Splicer - T Post					
	10145-000	-	1.2	112	\$10.76
14 gauge					
Foot Plate					
	10103-000-330	A/T	.3	50	\$4.24
4" x 2", 14 gauge Available in #330 Aluminum only					
Single Rivet Beam					
	•10063-000	12"	.5	20	\$2.26
	•10063-001	15"	.6	20	2.60
	•10063-002	18"	.7	20	2.88
	•10063-003	24"	1.0	20	3.22
	•10063-004	30"	1.2	20	3.62
	•10063-005	36"	1.5	20	3.98
	•10063-006	42"	1.7	20	4.60
	•10063-007	48"	2.0	20	4.98
1" high, 14 gauge					
Double Rivet Low Profile Beam					
	•16330-091	36"	1.8	14	\$5.86
	•16331-001	42"	2.1	14	6.98
	•16331-011	48"	2.5	14	7.66
1-1/4" high, 14 gauge					

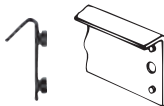
Catalog No.	Size	Wt. Each	Qty. Per Pack	List Price	
Double Rivet Z Beam					
	10142-000	12"	.9	20	\$3.46
	10142-001	15"	1.0	20	3.78
	10142-002	18"	1.3	20	4.72
	10142-003	24"	1.5	20	5.30
	10142-004	30"	2.1	20	6.34
	10142-012	32"	2.1	20	6.90
	10142-005	36"	2.5	20	7.38
	10142-006	42"	2.9	20	8.40
	10142-007	48"	3.5	10	9.36
	10142-008	60"	4.2	10	11.16
	10144-009	69"	4.9	10	14.66
	10144-010	72"	5.1	10	14.68
2-1/4" high, 14 gauge					
Z Tie					
	10110-003	24"	3.0	10	\$5.84
	10110-004	30"	4.2	10	6.90
	10110-012	32"	4.5	10	7.52
	10110-005	36"	5.1	10	7.86
	10110-006	42"	6.0	10	9.14
	10110-007	48"	6.9	10	10.52
Double Rivet Angle Beam					
	•10068-000	12"	.9	20	\$3.20
	•10068-001	15"	1.0	20	3.64
	•10068-002	18"	1.3	20	4.18
	•10068-003	24"	1.7	20	4.92
	•10068-004	30"	2.1	20	5.84
	•10068-012	32"	2.2	20	6.28
	•10068-005	36"	2.5	20	7.08
	•10068-006	42"	2.9	20	8.02
	•10068-007	48"	3.4	10	9.10
	•10068-008	60"	4.2	10	11.32
	•10068-009	69"	4.9	10	12.68
	10097-009 *	69"	4.9	10	14.60
	•10068-010	72"	5.1	10	13.26
	•10068-013	84"	6.0	10	16.08
	•10068-011	96"	6.8	10	17.64
2-5/8" x 7/8", 14 gauge					
*Punched to accept Record Storage Support Angle					
Double Rivet Channel Beam					
	•10070-007	48"	4.8	8	\$12.58
	•10070-008	60"	6.0	8	14.94
	•10070-009	69"	6.9	8	16.94
	10098-009 *	69"	6.9	8	18.94
	•10070-010	72"	7.2	8	17.54
	•10070-013	84"	8.4	8	21.30
	•10070-011	96"	9.6	8	23.10
3" x 7/8", 14 gauge					
Channel beams cannot be located directly at floor level.					
For a beam level directly at floor level, use angle beams with support ties.					
*Punched to accept Record Storage Support Angle.					
Support Tie					
	•10072-000	12"	1.0	20	\$5.20
	•10072-001	15"	1.3	20	5.22
	•10072-002	18"	1.5	20	5.28
	•10072-003	24"	1.9	20	6.14
	•10072-004	30"	2.3	20	6.78
	•10072-012	32"	2.6	20	7.32
	•10072-005	36"	2.8	10	7.80
	•10072-006	42"	3.2	10	8.68
	•10072-007	48"	3.9	10	9.88
2-1/2" high, 14 gauge					
Tire Beam					
	10077-005	36"	3.7	10	\$7.58
	10077-007	48"	4.9	10	9.62
	•10077-008	60"	6.1	10	11.02
2-23/32" high, 14 gauge					

Special height Angle Posts are available in 1-1/2" increments and special height T Posts are available in 12" increments. For these special height Angle or T Posts - in quantities less than 200 pieces, use the next taller size list price plus a set-up charge of \$85.00 net per line item. For quantities greater than 200 pieces, please contact the factory for prices.

RIVET-SPAN®

RIVET-SPAN® Components

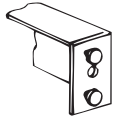
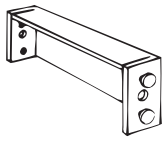
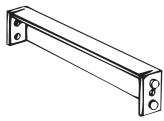
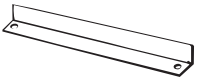
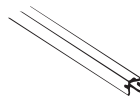
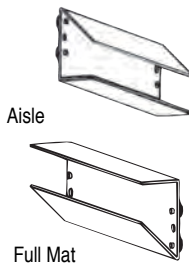
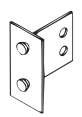
Catalog No.	Size	Wt. Each	Qty. Per Pack	List Price	
Aisle Tie*					
	10073-000	30"	2.5	10	\$7.50
	•10073-001	36"	2.9	10	8.54
	10073-002	42"	3.4	10	9.56
	10073-003	48"	3.9	10	10.92
2-1/2" high, 14 gauge *Not designed to support upper level walkways.					
Back Spacer Tie					
	•10079-000	18"	1.5	10	\$5.50
2-1/2" high, 14 gauge					
Wall Tie					
	•10075-000	9"	.8	10	\$5.34
2-1/2" high, 14 gauge					
Record Storage Support Angle					
	10099-000	15"	1.0	20	\$4.42
	10099-001	30"	2.0	10	6.74
1-17/32" high, 14 gauge					
Hang Rod					
	10104-005	36"	2.3	10	\$7.78
	10104-007	48"	3.2	10	10.12
	10104-008	60"	4.1	10	11.84
1-1/4" x 1-1/4", 14 gauge					
Aisle/Full Mat Decking Support					
	10111-005	36"	8.9	4	\$19.22
	10111-006	42"	10.4	4	22.82
	10111-007	48"	11.8	4	24.24
	10111-008	60"	14.7	4	29.52
	10111-009	69"	16.8	4	33.48
	10111-010	72"	17.3	4	34.74
Aisle Full Mat 3-1/2" high, 12 gauge					
Slotted Angle Cleat					
	10113-000	Right	.3	50	\$2.24
	10113-001	Left	.3	50	2.24
14 gauge					

Important:
Wall, floor or top tie anchoring is recommended for units when the height to depth ratio exceeds 4.
Example: A 7/84" high x 18" deep unit has a height to depth ratio of 4.67 and should be attached to a firm restraint, such as a floor, wall or tied overhead across the aisle to an opposite upright assembly.

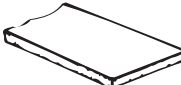
Catalog No.	Size	Wt. Each	Qty. Per Pack	List Price	
Particle Board Decking					
	10095-000	36" x 12"	7.8	**	\$6.90
	10095-001	36" x 15"	9.6	**	8.68
	•10095-002	36" x 18"	11.5	**	10.36
	•10095-003	36" x 24"	15.1	**	13.72
	10095-004	36" x 30"	19.3	**	17.18
	10095-005	42" x 12"	9.0	**	\$8.40
	•10095-006	42" x 15"	11.2	**	10.50
	10095-007	42" x 18"	13.3	**	12.58
	10095-008	42" x 24"	17.6	**	16.70
	10095-009	42" x 30"	22.3	**	20.86
	10095-010	48" x 12"	10.3	**	\$9.22
	10095-011	48" x 15"	12.7	**	11.46
	•10095-012	48" x 18"	15.1	**	13.72
	•10095-013	48" x 24"	20.5	**	18.30
	10095-014	48" x 30"	25.4	**	22.84
	10095-015	48" x 36"	30.3	**	27.42
	•10095-016	48" x 48"	40.0	**	36.62
	10095-017	60" x 18"	19.3	**	\$17.18
	•10095-018	60" x 24"	25.4	**	22.84
	10095-019	60" x 30"	31.5	**	28.56
	•10095-020	60" x 36"	37.6	**	34.22
	•10095-021	60" x 48"	49.8	**	54.76
	•10095-022	69" x 15"	18.5	**	\$17.50
	•10095-023	69" x 24"	29.0	**	28.02
	•10095-024	69" x 30"	36.0	**	35.02
	•10095-035	69" x 48"	57.1	**	54.72
	10095-025	72" x 18"	22.9	**	\$20.60
	•10095-026	72" x 24"	30.3	**	27.42
	10095-027	72" x 30"	37.7	**	34.26
	•10095-028	72" x 36"	44.9	**	41.06
	•10095-029	72" x 48"	59.5	**	54.76
	10095-041	84" x 36"	52.2	**	\$54.76
	10095-030	96" x 18"	30.3	**	\$27.42
	•10095-031	96" x 24"	40.0	**	36.56
	10095-032	96" x 30"	49.8	**	45.62
	•10095-033	96" x 36"	59.5	**	54.76
	•10095-034	96" x 48"	79.0	**	73.00
5/8" thick **Packed per order					

Intermix Beam Families on the Same Beam Level

These beam families can be intermixed without decking problems:

- ◆ Single Rivet Beams
- ◆ Double Rivet Low Profile Beams
- ◆ Double Rivet Z Beams

These beam families can be intermixed without decking problems:

- ◆ Double Rivet Angle Beams
- ◆ Double Rivet Channel Beams

The above groupings cannot be intermixed and support decking.

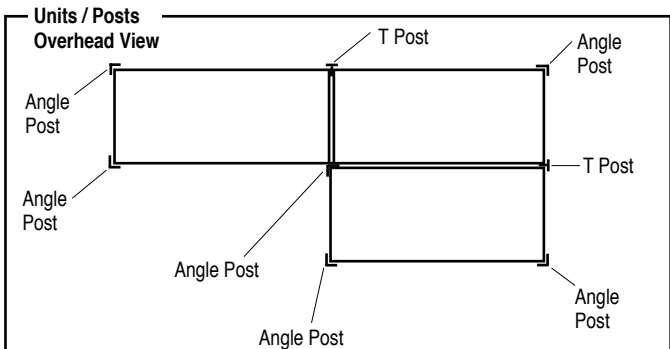

RIVET-SPAN®

RIVET-SPAN® Specifications

Specification Data

Rivet-Span® shelving units are made up of posts, side-to-side beams, and front-to-back beams. There are certain **minimum requirements** for beam use to ensure structural stability and safety. For example: all units must have a full "perimeter" of double rivet beams, meaning two side-to-side and two front-to-back, at both top and bottom of unit for stability. There are other requirements, see below.

Preconfigured Units - Include all required beams. Installation instructions (included with shipment) show how to position beams correctly.

Non-preconfigured Units - Follow these guidelines when specifying individual components:

- ◆ All units require a full perimeter of double rivet beams at top and bottom of unit.
- ◆ Single Rivet Beam (SRB) and Double Rivet Low Profile Beam (DRLPB) units 24" deep or less:
 - ◆ do not require SRB's front-to-back at each intermediate level in the unit.
 - ◆ 6'-8' high must have one SRB intermediate level front-to-back, located approximately in the middle of the unit.
 - ◆ 9'-10' high must have two SRB intermediate levels front-to-back, located to divide the height into 3 equal parts.
 - ◆ 11'-16' high must have three intermediate levels; a full perimeter of Double Rivet Beams (DRB) in the middle plus intermediate levels of front-to-back SRB's in the upper and lower halves of unit.
- ◆ Single Rivet Beam (SRB) and Double Rivet Low Profile Beam (DRLPB) units 30" deep or greater:
 - ◆ All units must have SRB's front-to-back at every intermediate level; units 11'-16' must have SRB's front-to-back at every intermediate level PLUS a full perimeter level of Double Rivet Beams (DRB) located approximately in the middle of the unit.
- ◆ Double Rivet Angle Beams (DRAB) and Double Rivet Channel Beams (DRCH) must have front-to-back beams at each beam level to provide decking support and ensure stability. When using DRCH from side-to-side, DRAB must be used from front-to-back.
- ◆ Tie Plates are recommended to tie adjacent Angle Post units together and to ensure structural stability. Tie plates should be used at the top and bottom of adjacent posts with additional tie plates spaced no more than 48" apart. Tie plates are not used on units with T Posts.

Basic Data

Widths

Nominal unit width = 24", 30", 32", 36", 42", 48", 60", 69", 72", 84" or 96"
 Actual single unit width = nominal width + 1/2"

Depths

Nominal unit depth = 12", 15", 18", 24", 30", 32", 36", 42" or 48"
 Actual single unit depth = nominal depth + 1/2"
 Actual back-to-back units depth = combined actual unit depths + 7/32"

Heights

Nominal unit height = 6'/72", 7'/84", 8'/96", 10'/120", 12'/144", 14'/168", 15'/180" or 16'/192"
 Actual unit height = nominal height ± 1/32"

Length of Run

Actual length of run = sum of actual unit widths + 7/32" per adjoining unit

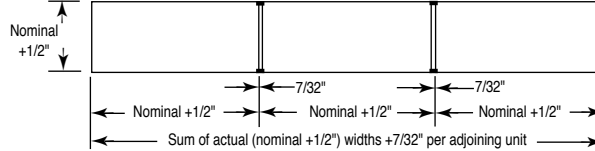

Horizontal Clear Openings

Actual clear opening between angle posts = nominal width - 2-5/8"
 Actual clear opening between heavy-duty angle posts = nominal width - 3-1/4"

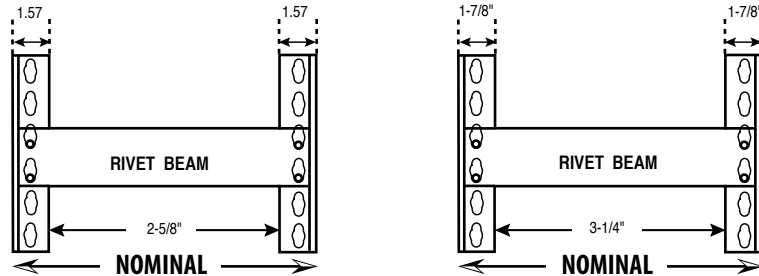

Vertical Adjustment

All beams are adjustable on 1-1/2" centers

Vertical Clear Openings

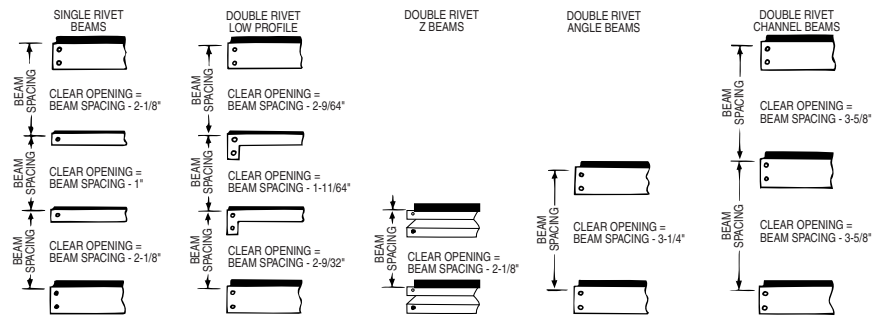

Vertical clearance calculated using 5/8" thick decking material.

RIVET-SPAN® Specifications *(continued)*

Decking Material

Particle board decking, 5/8" (.625) thick, is available pre-cut from Borroughs and your local Borroughs Distributor. It can also be obtained from your local building material supplier. Other types and thicknesses of decking material, such as plywood, structure wood, oriented strand board or wire decking may be desired based upon load or use. These also can be obtained from your Borroughs Distributor.

When supplying your own decking material, cut the decking to the nominal unit size +0" - 1/8" (.125). If single rivet beams or double rivet low profile beams are being used in the left-to-right position, cut the decking material 3/16" (.188) under the nominal unit depth for easier assembly. Similarly, if either of these types of beams are being used in the front-to-back position to support the decking, also cut the decking material 3/16" (.188) under the nominal unit width.

Calculated Post Capacities

Pounds Allowable Load Per Post

Maximum Beam Spacing In Inches	Angle Post	Heavy-Duty Angle Post
48"	1,170	1,750
42"	1,315	1,960
36"	1,460	2,180
30"	1,605	2,390
24"	1,750	2,610
18"	1,896	2,830
12"	2,040	3,050

◆ Maximum beam spacing is determined as the distance between left-to-right beams or front-to-back beams, whichever is greater.

◆ Capacities are for vertical loads only where seismic forces are not a factor.

Beam Capacities

Maximum Uniformly Distributed Loads Pounds Per Beam Pair **

Beam Length	Single Rivet Beam	Double Rivet Low Profile Beam	Double Rivet Z Beam	Double Rivet Z Beam w/Z Tie*	Double Rivet Angle Beam	Double Rivet Angle Beam w/Support Tie*	Double Rivet Channel Beam w/Support Tie*
36"	350	450	1,400	-	1,400	-	-
42"	260	430	1,350	-	1,000	-	-
48"	240	400	1,300	1,600	730	1,700	-
60"	-	-	800	950	680	1,300	2,250
69"	-	-	600	900	460	1,100	1,900
72"	-	-	600	900	450	1,050	1,700
96"	-	-	-	-	240	650	1,300

*One support tie except 96" which has two.



**The longest pair of beams at a given level determines the capacity for the entire level. Capacities are for steel beams only and do not reflect the capacity of the decking material.



Important:

Wall, floor or top tie anchoring is recommended for units when the height to depth ratio exceeds 4.

Example: A 7/84" high x 18" deep unit has a height to depth ratio of 4.67 and should be attached to a firm restraint, such as a floor, wall or tied overhead across the aisle to an opposite upright assembly.



Slotted Angle

Catalog No.	Size	Wt. Per Bundle	Qty. Per Pack	List Price
				
1.25" x 1.25", 14 gauge				
•SA125-10	10'	57.0	10/bdl.	\$174.02/bdl.
Includes 75 bolts and nuts and 30 washers per bundle				
				
1.57" x 1.57", 14 gauge				
•SA160-10	10'	70.0	10/bdl.	\$192.52/bdl.
Includes 75 bolts and nuts and 30 washers per bundle				
				
2.38" x 1.62", 14 gauge				
•SA225-10	10'	85.0	10/bdl.	\$229.90/bdl.
•SA225-12	12'	101.0	10/bdl.	253.26/bdl.
Includes 75 bolts and nuts and 30 washers per bundle				

Catalog No.	Size	Wt. Per Bundle	Qty. Per Pack	List Price
				
3.12" x 1.61", 12 gauge				
•SA312-10	10'	136.0	10/bdl.	\$332.18/bdl.
•SA312-12	12'	163.0	10/bdl.	408.98/bdl.
Includes 75 bolts and nuts and 30 washers per bundle				
				
Additional Bolts, Nuts & Washers 75 Bolts ♦ 75 Nuts ♦ 30 Washers				
00527-000	5/16" x 5/8"	5.0	Pkg.	\$19.82/pkg.
NOTE: Connection Load Limit: With a safety factor of 1.5, the load limit per bolt is 1120 lbs. (Example: A shelf loaded with 5000 lbs. would result in load of 1250 lbs. per connection and would require two (2) bolts per connection).				

SLOTTED ANGLE





Column Sections

Unsupported Length in Feet	Type	3'	4'	5'	6'	7'	8'	9'	10'
	125	810	590	420	290	-	-	-	-
	160	1460	1170	970	770	-	-	-	-
	225	1890	1420	1130	940	700	-	-	-
	312	3490	2890	1990	1300	1060	-	-	-
	125	1780	1240	880	600	-	-	-	-
	160	3860	3510	3200	2700	-	-	-	-
	225	4770	4500	4190	2840	2350	1900	1500	1050
	312	7160	5450	5000	4550	3700	2590	2190	1740
	125	1780	1240	880	600	-	-	-	-
	160	3860	3510	3200	2700	-	-	-	-
	225	4770	4500	4190	2840	2350	1900	1500	1050
	312	7160	5450	5000	4550	3700	2590	2190	1740

Load in pounds
NOTE: Upright loadings are allowable axial loads for the unsupported heights listed. If loads are eccentric, they should be reduced.

Available in full bundles only. No split packages allowed.

Beam Sections

Length of Beams in Feet	Type	3'	4'	5'	6'	7'	8'	9'	10'
	125	510	290	-	-	-	-	-	-
	160	820	540	370	260	-	-	-	-
	225	1590	1120	830	640	510	410	-	-
	312	2790	1950	1350	1050	840	660	480	-
	125	1080	830	585	420	-	-	-	-
	160	1390	1080	855	690	560	430	-	-
	225	3090	2230	1690	1380	1130	910	730	580
	312	6100	4470	3400	2730	2200	1750	1300	1090
	125	1300	960	650	440	270	-	-	-
	160	1680	1260	960	730	580	480	-	-
	225	3740	2930	2300	1810	1460	1170	960	800
	312	7860	5940	4690	3885	4330	2740	2210	1870
	125	750	660	530	400	-	-	-	-
	160	970	870	780	660	570	450	-	-
	225	2170	1800	1540	1330	1160	970	860	690
	312	4190	3580	3190	2810	2490	2190	1990	1830
	125	-	-	-	-	-	-	-	-
	160	-	-	-	-	-	-	-	-
	225	6370	4680	3570	3010	2630	2340	2110	1910
	312	12750	9650	7610	6610	5800	5100	4590	4070

Load in pounds.
NOTE: Combination sections are bolted together on 6" centers. All figures refer to a pair of beams carrying evenly distributed loads. For concentrated loads, these figures should be halved. The loads shown above are those which give a safety factor of 1.5 while limiting deflection.

FLEXI-BINS®

Preconfigured Units

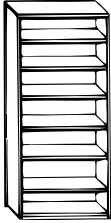
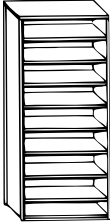
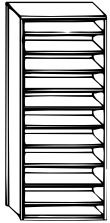
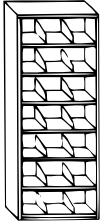
Catalog No.	Size	Wt. Each	List Price
			
FB101 6 Shelves Plus Top & Base	FB102 8 Shelves Plus Top & Base	FB103 10 Shelves Plus Top & Base	FB104 6 Shelves Plus Top & Base 14 Dividers - 6"
UNITS			
•FB101	38" x 12" x 7'0"/84"	104.3	\$331.36
•FB102	38" x 12" x 7'0"/84"	114.5	366.02
•FB103	38" x 12" x 7'0"/84"	124.7	400.66
FB104	38" x 12" x 7'0"/84"	118.3	397.68

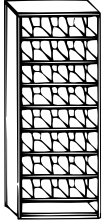
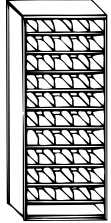
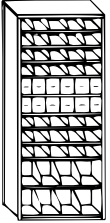
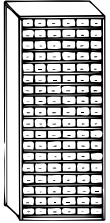
Catalog No.	Size	Wt. Each	List Price
			
FB105 8 Shelves Plus Top & Base 32 Dividers - 3"	FB106 10 Shelves Plus Top & Base 40 Dividers 3"	FB107 10 Shelves Plus Top & Base 34 Dividers/12 Drawers	FB108 17 Shelves Plus Top & Base 108 Drawers
UNITS			
•FB105	38" x 12" x 7'0"/84"	140.1	\$474.04
•FB106	38" x 12" x 7'0"/84"	156.7	535.68
FB107	38" x 12" x 7'0"/84"	173.5	673.68
FB108	38" x 12" x 7'0"/84"	333.2	1771.04

Components

Catalog No.	Size	Wt. Each	Qty. Per Pack	List Price
Bin Frames				
•PBF-12-84	38" x 12" x 7'0"/84"	73.7	-	\$227.36
PBF-12-96	38" x 12" x 8'0"/96"	86.7	-	269.66
Bin Frame Components				
•04445-099	Top	5.5	10	\$18.94
•02718-099	Base	7.2	10	25.28
•04611-099	Side - 7'0"/84"	17.2	10	\$54.44
•09221-099	Side - 8'0"/96"	21.8	10	67.28
Backs				
•• 04614-099	Back - 7'0"/84"	26.6	5	\$74.38
•• 09220-099	Back - 8'0"/96"	30.9	5	90.98
Shelves				
•02720-099 (label holder included)	Shelf - Standard	5.1	10	\$17.34
Sliding Shelf Dividers*				
14066-000	1-1/2" x 12"	.8	50	\$3.40
•14066-001	3" x 12"	.8	50	3.40
14066-002	4-1/2" x 12"	.9	50	4.32
14066-003	6" x 12"	1.0	50	4.76

Catalog No.	Size	Wt. Each	Qty. Per Pack	List Price
Drawer				
•04432-099	5-3/4" x 12"	1.6	24	\$11.58
•04436-099	Drawer Divider**	.1	200	1.52
Label Holders				
•07190-099	Full Length	.2	100	\$3.10
•02450-099	Clip-on	.1	500	1.26
•08897-099	Blank Labels	.2	240	11.50/pkg
Trim Panels				
13100-000	Single Face - 12" x 84"	14.0	2	\$90.50
13101-000	Double Face - 24" x 84"	26.3	2	147.32
Long Parts Frames				
09576-099	36" x 12" Frame	4.6	10	\$38.82
06238-860	Spacer Rod - 12"	.3	50	2.26
09576-098	36" x 18" Frame	5.0	10	\$41.22
06239-860	Spacer Rod - 18"	.4	50	2.72
09576-097	36" x 24" Frame	5.3	10	\$44.02
06240-860	Spacer Rod - 24"	.6	50	3.06
06242-099	Tie Angle (for use with Long Parts Frame)	1.8	10	\$26.76

AUTOMOTIVE STORAGE

*Patent Number: 3,780,876

**Available in #445 White only

Footprint: 38-1/16" x 12-1/32" (38.063" x 12.031")

All units Shipped K.D.



- Flexi-Bin pre-configured units and components **InStock** in #065 Industrial Gray, #445 White & #B504 Blue
- NOTE: All Flexi-Bin units will have #445 White backs
- Drawers **InStock** in #065 Industrial Gray and #445 White
- • Backs **InStock** in #445 White only

Automotive Storage Units

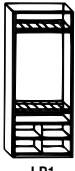
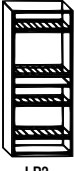
FLEXI-BIN® Long Parts Bins

Catalog No.		Unit Width	Unit Depth	Unit Height	Vertical Storage Levels	Bulk Storage Levels	Wt.	List Price
	LP1	38"	12"	7'84"	1	2	94.2	\$378.66
	LP2	38"	12"	7'84"	2	0	99.5	\$452.82

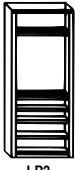



BOX EDGE PLUS® Long Parts Bins

Catalog No.		Unit Width	Unit Depth	Unit Height	Vertical Storage Levels	Bulk Storage Levels	Wt.	List Price
	LP3	36"	18"	7'3'87"	1	3	123.0	\$441.84
	LP4	36"	18"	7'3'87"	2	0	117.5	\$492.66

BOX EDGE PLUS® Horizontal Molding Racks

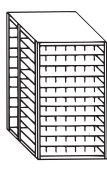
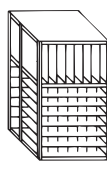
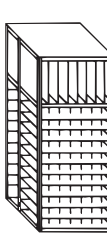
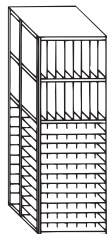
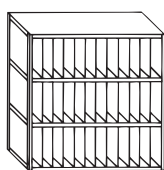
Catalog No.	Unit Width	Unit Depth	Unit Height	Openings	Opening Size	Wt.	List Price
 HMR36-126	36"	54"	7'3'87"	126	Adjustable	474.4	\$1702.04

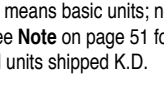
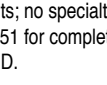
RIVET-SPAN® Horizontal and Wheel House Molding Racks

Catalog No.		Unit Width	Unit Depth	Unit Height	Openings	Opening Size	Wt.	List Price
	BMR1-4860	48"	60"	6'72"	77	6" x 5"	171.6	\$442.30
	BMR1+4860	48"	60"	6'72"	77	6" x 5"	365.7	914.24
	BMR2-4860	48"	60"	6'72"	57	(49) 6" x 5" (8) 5-1/2" x 24"	157.6	\$411.10
	BMR2+4860	48"	60"	6'72"	57	(49) 6" x 5" (8) 5-1/2" x 24"	283.8	924.48
	BMR3-4860	48"	60"	8'96"	85	(77) 6" x 5" (8) 5-1/2" x 24"	205.6	\$530.44
	BMR3+4860	48"	60"	8'96"	85	(77) 6" x 5" (8) 5-1/2" x 24"	443.4	1158.92
	BMR4-4860	48"	60"	10'120"	93	(77) 6" x 5" (16) 5-1/2" x 24"	231.8	\$600.70
	BMR4+4860	48"	60"	10'120"	93	(77) 6" x 5" (16) 5-1/2" x 24"	499.1	1397.54
	BMR5-9648	96"	48"	7'84"	48	5-1/2" x 24"	103.2	\$262.86
	BMR5+9648	96"	48"	7'84"	48	5-1/2" x 24"	431.5	1236.50

(-) means basic units; no specialty components; (+) are complete units.
See **Note** on page 51 for complete information.

All units shipped K.D.

AUTOMOTIVE STORAGE

Automotive Storage Units

RIVET-SPAN® Sheet Metal Racks

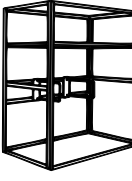
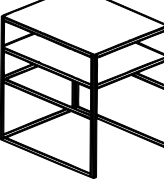
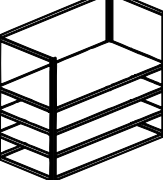
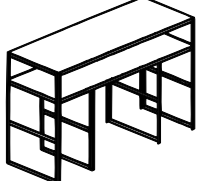
Catalog No.		Unit Width	Unit Depth	Unit Height	Application	Wt.	List Price
 BSR1	BSR1-7236	72"	36"	8'/96"	Bulky Parts	85.2	\$218.48
	BSR1+7236	72"	36"	8'/96"	Bulky Parts	256.3	390.12
 BSR2	BSR2-7236	72"	36"	8'/96"	Bumpers & Bars	89.6	\$299.18
	BSR2+7236	72"	36"	8'/96"	Bumpers & Bars	218.1	429.82
 BSR3	BSR3-7236	72"	36"	8'/96"	Fenders & Door	91.6	\$425.54
	BSR3+7236	72"	36"	8'/96"	Fenders & Door	220.1	556.14
 BSR4	BSR4-7236	72"	36"	8'/96"	Two Tier Fender	94.8	\$632.58
	BSR4+7236	72"	36"	8'/96"	Two Tier Fender	180.4	722.18
 BSR5	BSR5-9636	96"	36"	8'/96"	Hanging Parts	92.0	\$235.98
	BSR5+9636	96"	36"	8'/96"	Hanging Parts	274.4	578.56
 BSR6	BSR6-4848	48"	48"	8'/96"	Hoods	68.6	\$174.22
	BSR6+4848	48"	48"	8'/96"	Hoods	145.0	254.90
 BSR7	BSR7-4860	48"	60"	8'/96"	Deep Hoods	86.8	\$220.72
	BSR7+4860	48"	60"	8'/96"	Deep Hoods	182.4	337.70
 BSR8	BSR8-7236	72"	36"	8'/96"	Top Tier Fenders	95.3	\$245.80
	BSR8+7236	72"	36"	8'/96"	Top Tier Fenders	267.5	432.48
 BSR9	BSR9-9636	96"	36"	8'/96"	Quarter Panels	109.4	\$304.48
	BSR9+9636	96"	36"	8'/96"	Quarter Panels	223.8	428.98

(-) means basic units; no specialty components; (+) are complete units.
See **Note** on page 51 for complete information.
All units shipped K.D.



Perforated End Panel

Catalog No.	Size	Wt. Each	List Price
05157-003	18" x 75"	29.0	\$142.48
05157-004	18" x 87"	34.0	152.28
05157-005	18" x 99"	39.0	163.02
05158-003	24" x 75"	38.0	\$151.18
05158-004	24" x 87"	43.0	163.02
05158-005	24" x 99"	48.0	179.10

16 gauge steel
Available in any standard Industrial color. Please specify at time of order.
Compatible with all standard pegboard accessories.
Can be mounted on any Borroughs angle post or can be wall mounted.

AUTOMOTIVE STORAGE

Automotive Storage Units

RIVET-SPAN® Tire Racks

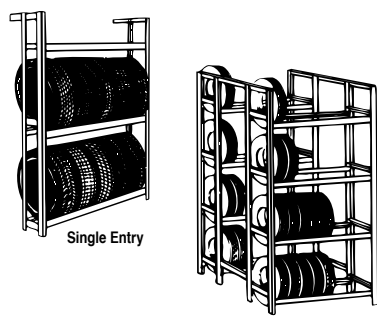
	Catalog No.	Unit Width	Unit Depth	Unit Height	Beam Levels	Tire Capacity*	Wt.	List Price
 <p>Single Entry</p> <p>Double Entry</p>	•B60SETB37	60"	12"	7'/84"	3	24	68.8	\$161.88
	•B60SETB40	60"	12"	10'/120"	4	32	91.8	213.56
	•B60SETB52	60"	12"	12'/144"	5	40	111.6	258.98
	•B60DETB37	60"	42"	7'/84"	3	48	136.4	\$303.54
	•B60DETB40	60"	42"	10'/120"	4	64	182.4	406.90
	•B60DETB52	60"	42"	12'/144"	5	80	222.0	497.28

*Approximate capacities based upon average automobile tire.

• InStock in #161 Mist Gray Only

Battery Racks

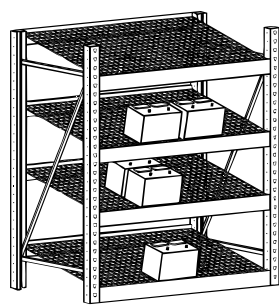
	Catalog No.	Battery Capacity	Unit Width	Unit Depth	Unit Height	Description	Wt.	List Price
 <p>Battery Rack</p>	*11135-000	100	60"	36"	68"	Starter Unit	300.0	\$1295.28
	*11136-000	100	60"	36"	68"	Adder Unit	280.0	\$1237.70

*F.O.B. Dallas, Texas

Bedliner Racks

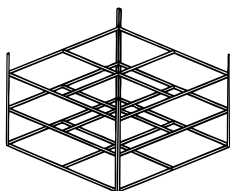
	Catalog No.	Unit Width	Unit Depth	Unit Height	Application	Wt.	List Price
 <p>BLR1+8484</p>	BLR1+8484	84"	84"	7'/84"	Bedliners	138.0	\$352.12

Quicklane Counter Unit with Stainless Steel Top

	Catalog No.	Unit Width	Unit Depth	Unit Height	Wt.	List Price
	HDC7224	72"	25"	39"	750.0	\$4358.80
	HDC8424	84"	25"	39"	800.0	4195.24
	Countertop Only					
	11150-004-000	72"	25"		40.0	\$563.32
	11150-003-000	84"	25"		45.0	575.68

AUTOMOTIVE STORAGE

Automotive Storage Units

Counter Units

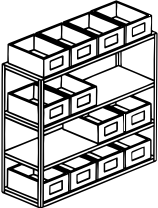
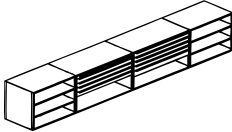
Catalog No.	Unit Width	Unit Depth	Unit Height	Application	Wt.	List Price	
 B7224DR47+P	B7224DR47+P	72"	24"	7'84"	Pre-Pick Unit	90.0	\$1001.12
	includes (16) 15-1/2"w x 23-1/2"d x 12"h totes with label holders						
 BHDC1	BHDC1-168	168-3/16"	24"	38-3/4"	Fast Zone Counter	925.4	\$5185.40
	BHDC1+168*	168-3/16"	24-1/4"	40"	Fast Zone Counter	1065.4	6347.98
	[(2) 36" x 24" shelf units and (2) 48" x 24" drawer units with a total of (10) drawers: (1) 3" 55 compartments, (8) 4-1/2" 28 compartments and (1) 6" 24 compartments]						
	*The +168 unit includes a Formica Mouse Gray top; the -168 unit does not include a top.						

HD Drawer Bulky Bins

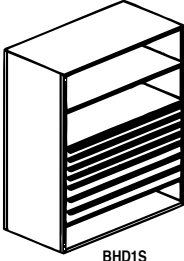
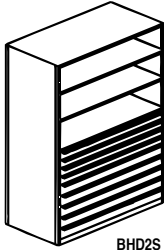
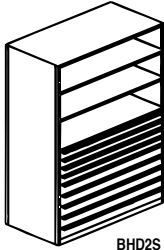
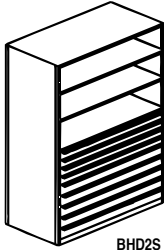
Catalog No.	Unit Width	Unit Depth	Unit Height	HD Drawer Bulky Bin Starter or Adder	Wt.	List Price	
 BHD1S	BHD1S-3624	36"	24"	7'3"/87"	Starter	494.8	\$2615.30
	BHD1A-3624	36"	24"	7'3"/87"	Adder	482.4	2571.38
drawers: (4) 4-1/2" 20 compartments and (3) 6" 16 compartments							
 BHD2S	BHD1S-4824	48"	24"	7'3"/87"	Starter	605.5	\$3426.40
	BHD1A-4824	48"	24"	7'3"/87"	Adder	593.1	3382.46
drawers: (4) 4-1/2" 28 compartments and (3) 6" 24 compartments							
 BHD2S	BHD2S-3624	36"	24"	8'3"/99"	Starter	628.5	\$3300.16
	BHD2A-3624	36"	24"	8'3"/99"	Adder	612.1	3248.80
drawers: (4) 4-1/2" 20 compartments and (5) 6" 16 compartments							
 BHD2S	BHD2S-4824	48"	24"	8'3"/99"	Starter	775.3	\$4384.00
	BHD2A-4824	48"	24"	8'3"/99"	Adder	758.9	4332.60
drawers: (4) 4-1/2" 28 compartments and (5) 6" 24 compartments							

RIVET-SPAN® Automotive Accessories

Catalog No.	Description	Size	Wt.	List Price
14150-001	Divider Arm	24"	1.4	\$26.90
10118-000	Loop Divider Arm	26" x 15"	3.0	\$103.54
10119-000	J Hook Rail (galvanized) (20 J hooks included)	96"	7.0	\$139.76
94242-069-330	Heavy-Duty J Hooks	6-3/4"h x 2-1/4"w	.3	\$5.50
•10178-000-000	Plastic Label Holder	4'	.3	\$3.72
10178-001-000	Plastic Label Holder	8'	.5	7.36
10460-000	Magnetic Label Holder (dark brown)	4'	.8	\$12.32
•10127-000	Acrylic Divider Rod (clear)	3/16" x 6'7/2"	.2	\$5.90
10128-000	Pegboard Decking (natural)	48" x 24" x 1/4"	9.0	\$22.84
10128-001	Pegboard Decking (natural)	48" x 36" x 1/4"	14.0	28.08
10129-000	Cardboard Sleeves (8 openings 5-1/2" x 24") (white exterior, natural interior)	48" x 48" x 24"	8.9	\$111.74/set

Note:

Rivet-Span automotive pre-configured units with (-) are basic units and do not include any specialty components other than divider arms, loop divider bars, wall ties or back spacer ties. Models with (+) are complete units and include all necessary wood decking/pegboard, cardboard sleeves, acrylic rods, J rails and hooks, or magnetic label holders.

Rivet-Span automotive pre-configured units' double rivet beams are Double Rivet Angle Beams except on Tire Racks which have Tire Beams in the left to right positions.

Support Ties not included in any pre-configured Rivet-Span automotive units. Refer to Beam Capacity Chart to access your application

Rivet-Span horizontal molding units' acrylic divider rods must be field cut to length.

All units shipped K.D.

AUTOMOTIVE STORAGE

Record Holders

BOX EDGE PLUS® Archive Records Storage

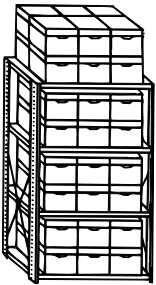
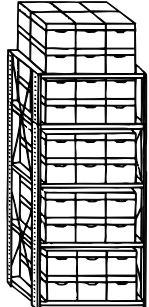
	Catalog No.	Unit Type	Unit Width	Unit Depth	Unit Post Height	Shelf Levels	Type of Box	Box Capacity	Weight	List Price	
 <p>RS-423075</p>  <p>RS-423099</p>	•RS-423075	Starter	42"	30"	6'3"/75"	4	1 cu. ft.	48	106.0	\$316.60	
	•RA-423075	Adder	42"	30"	6'3"/75"	4	1 cu. ft.	48	93.0	280.00	
	RS-423275	Starter	42"	32"	6'3"/75"	4	1 cu. ft.	48	107.0	333.42	
	RA-423275	Adder	42"	32"	6'3"/75"	4	1 cu. ft.	48	94.0	296.56	
	Boxes stored 3 across x 2 high x 2 deep - All shelf levels utilized for storage										
	•RS-423099	Starter	42"	30"	8'3"/99"	5	1 cu. ft.	60	138.0	\$420.82	
	•RA-423099	Adder	42"	30"	8'3"/99"	5	1 cu. ft.	60	119.0	356.44	
	RS-423299	Starter	42"	32"	8'3"/99"	5	1 cu. ft.	60	139.0	442.20	
	RA-423299	Adder	42"	32"	8'3"/99"	5	1 cu. ft.	60	120.0	377.32	
	Boxes stored 3 across x 2 high x 2 deep - All shelf levels utilized for storage										
RS-422475	Starter	42"	24"	6'3"/75"	4	1.5 cu. ft.	24	102.0	\$277.68		
RA-422475	Adder	42"	24"	6'3"/75"	4	1.5 cu. ft.	24	90.0	241.58		
Boxes stored 3 across x 2 high x 1 deep - All shelf levels utilized for storage											
RS-422499	Starter	42"	32"	8'3"/99"	5	1.5 cu. ft.	30	133.0	\$371.40		
RA-422499	Adder	42"	32"	8'3"/99"	5	1.5 cu. ft.	30	115.0	308.02		
Boxes stored 3 across x 2 high x 1 deep - All shelf levels utilized for storage											
Records Storage Box Information: 1 cu. ft. size = 12-7/8"w x 15-5/8"d x 10-1/2"h 1.5 cu. ft. size = 12-5/8"w x 24"d x 10-1/4"h											
Record storage boxes not included											
Units priced with beaded front posts and PLUS 2 shelves											

BOX EDGE PLUS® X-Ray Storage

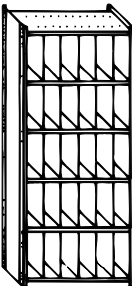
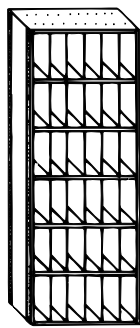
	Catalog No.	Unit Type	Unit Width	Unit Depth	Unit Post Height	Filing Levels	Filing Inches	Weight	List Price	
 <p>XS-361887</p>  <p>XS-3618100</p>	XS-361887	Starter	36"	18"	7'3"/87"	5	175"	199.0	\$745.64	
	XA-361887	Adder	36"	18"	7'3"/87"	5	175"	176.0	670.86	
	XS-3618100	Starter	36"	18"	8'4-1/2"/100-1/2"	6	210"	210.0	\$898.00	
	XA-3618100	Adder	36"	18"	8'4-1/2"/100-1/2"	6	210"	184.0	799.90	
	Units priced with beaded closed sides, #445 White backs and Plus 1 shelves									

RECORDS STORAGE

Important:

Wall, floor or top tie anchoring is recommended for units when the height to depth ratio exceeds 4.

Example: A 7'3"/87" high x 18" deep unit has a height to depth ratio of 4.83. Two 8'3"/99" high x 12" deep units back-to-back have a height to depth ratio of 4.12. These units should be attached to a firm restraint, such as a floor, wall or tied overhead across the aisle to an opposite upright assembly.

Record Holders

RIVET-SPAN® Archive Records Storage

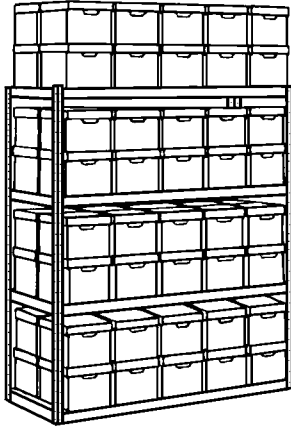
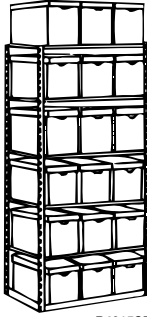
	Starter Units Catalog No.	List Price	Adder Units Catalog No.	List Price	Unit Width	Unit Depth	Post Height	Beam Levels	Type of Box	Box Capacity	Weight		
 <p>B6930DH47</p> <p>For use with decking</p>	•B6915DR36	\$140.00	•A6915DR36	\$131.76	69"	15"	6'/72"	3	1 cu. ft.	30	53.8		
	•B6915DR47	179.60	•A6915DR47	169.60	69"	15"	7'/84"	4	1 cu. ft.	40	68.8		
	•B6915DR59	226.04	•A6915DR59	213.10	69"	15"	9'/108"	5	1 cu. ft.	50	86.6		
	Boxes stored 5 across x 2 high x 1 deep - All beam levels utilized for storage												
	•B6930DH36	\$173.38	•A6930DH36	\$165.12	69"	30"	6'/72"	3	1 cu. ft.	60	68.5		
	•B6930DH47	224.10	•A6930DH47	214.12	69"	30"	7'/84"	4	1 cu. ft.	80	88.5		
	•B6930DH59	281.66	•A6930DH59	268.70	69"	30"	9'/108"	5	1 cu. ft.	100	111.1		
	Boxes stored 5 across x 2 high x 2 deep - All beam levels utilized for storage												
	•B6948CH36	\$219.36	A6948CH36	\$211.08	69"	48"	6'/72"	3	1 cu. ft.	90	102.4		
	•B6948CH47	288.26	A6948CH47	278.24	69"	48"	7'/84"	4	1 cu. ft.	120	133.6		
	•B6948CH59	363.98	A6948CH59	351.02	69"	48"	9'/108"	5	1 cu. ft.	150	167.6		
	Boxes stored 5 across x 2 high x 3 deep - All beam levels utilized for storage												
	•B6924DR36	\$147.66	•A6924DR36	\$139.42	69"	24"	6'/72"	3	1.5 cu. ft.	30	58.0		
	•B6924DR47	189.84	•A6924DR47	179.82	69"	24"	7'/84"	4	1.5 cu. ft.	40	74.4		
	•B6924DR59	238.80	•A6924DR59	225.88	69"	24"	9'/108"	5	1.5 cu. ft.	50	93.6		
	Boxes stored 5 across x 2 high x 1 deep - All beam levels utilized for storage												
	•B6948CH36	\$219.36	A6948CH36	\$211.08	69"	48"	6'/72"	3	1.5 cu. ft.	60	102.4		
	•B6948CH47	288.26	A6948CH47	278.24	69"	48"	7'/84"	4	1.5 cu. ft.	80	133.6		
	•B6948CH59	363.98	A6948CH59	351.02	69"	48"	9'/108"	5	1.5 cu. ft.	100	167.6		
	Boxes stored 5 across x 2 high x 2 deep - All beam levels utilized for storage												
	Includes Records Storage Support Angles No Decking Required	B6915PR36	\$283.40	A6915PR36	\$275.14	69"	15"	6'/72"	3	1 cu. ft.	30	83.8	
		B6915PR47	363.78	A6915PR47	360.80	69"	15"	7'/84"	4	1 cu. ft.	40	108.8	
		Boxes stored 5 across x 2 high x 1 deep - All beam levels utilized for storage											
		B6930PH36	\$404.38	A6930PH36	\$396.14	69"	30"	6'/72"	3	1 cu. ft.	60	128.5	
B6930PH47		528.24	A6930PH47	518.26	69"	30"	7'/84"	4	1 cu. ft.	80	168.6		
Boxes stored 5 across x 2 high x 2 deep - All beam levels utilized for storage													
 <p>B4215SR66</p> <p>For use with decking</p>	•B4215SR66	\$130.68	A4215SR66	\$122.44	42"	15"	6'/72"	6	1 cu. ft.	18	48.8		
	•B4215SR77	146.88	A4215SR77	136.86	42"	15"	7'/84"	7	1 cu. ft.	21	55.4		
	•B4215SR88	162.96	A4215SR88	151.12	42"	15"	8'/96"	8	1 cu. ft.	24	61.6		
	Boxes stored 3 across x 1 high x 1 deep - All beam levels utilized for storage												
	•B4224SR66	\$137.10	A4224SR66	\$128.82	42"	24"	6'/72"	6	1.5 cu. ft.	18	52.4		
	•B4224SR77	153.26	A4224SR77	143.26	42"	24"	7'/84"	7	1.5 cu. ft.	21	59.0		
	•B4224SR88	169.34	A4224SR88	157.52	42"	24"	8'/96"	8	1.5 cu. ft.	24	65.2		
	Boxes stored 3 across x 1 high x 1 deep - All beam levels utilized for storage												

Record Storage Box Information:

1 cu. ft. size = 12-7/8" w x 15-5/8" d x 10-1/2" h
 1.5 cu. ft. size = 12-5/8" w x 24" d x 10-1/4" h

Record storage boxes not included.
 All units include metal framing only. Decking material must be ordered separately.
 All units shipped K.D.

Important:

Wall, floor or top tie anchoring is recommended for units when the height to depth ratio exceeds 4.

Example: A 7'/84" high x 18" deep unit has a height to depth ratio of 4.67 and should be attached to a firm restraint, such as a floor, wall or tied overhead across the aisle to an opposite upright assembly.

RECORDS STORAGE

Tech Benches and Storage Units

Enclosed Tech Bench

	Catalog No.	Unit W	Unit D	Unit H	Description	Wt.	List Price
 <p>Enclosed Tech Bench (shown with optional doors)</p>	WCL300	48"	28"	34"	Enclosed Tech Bench with Painted Top	104.0	\$701.28
	WCL300SS	48"	28"	34"	Enclosed Tech Bench with Stainless Steel Top	104.0	1003.34
	WSDL300	-	-	-	Sliding Door Kit with Lock (for WCL300 and WCL300SS)	20.0	290.72
	WCL302	60"	28"	34"	Enclosed Tech Bench with Painted Top	130.0	\$716.98
	WCL302SS	60"	28"	34"	Enclosed Tech Bench with Stainless Steel Top	130.0	1121.74
	WSDL302	-	-	-	Sliding Door Kit with Lock (for WCL302 and WCL302SS)	25.0	333.90
	WCL304	72"	28"	34"	Enclosed Tech Bench with Painted Top	156.0	\$847.84
	WCL304SS	72"	28"	34"	Enclosed Tech Bench with Stainless Steel Top	156.0	1215.48
	WSDL304	-	-	-	Sliding Door Kit with Lock (for WCL304 and WCL304SS)	30.0	344.12

Additional shelves, sliding doors and optional work surfaces are available and must be ordered separately.

Transmission Tear-Down Bench

	Catalog No.	Unit W	Unit D	Unit H	Description	Wt.	List Price
	11106-000	48"	28"	Adjustable	Tear-Down Bench with Painted Top	96.9	\$1151.36
	11106-001	48"	28"	Adjustable	Tear-Down Bench with Stainless Steel Top	91.9	1432.66
	14865-000	15-1/4"	20"	7-1/4"	Tier Drawer (must order supports below)	18.8	141.24
	14823-000				28" Tier Drawer Supports (required)	3.5	17.86

Wall Mounted Cabinet

	Catalog No.	Unit W	Unit D	Unit H	Description	Wt.	List Price
	11114-000	36"	13"	27"	Wall Mounted Cabinet	80.0	\$582.88
	11125-000	36"	13"	6"	Angled Top Kit	10.0	147.68

Taper Leg Enclosed Benches

	Catalog No.	Unit W	Unit D	Unit H	Wt.	Painted Top List Price	Stainless Steel Top List Price	
 <p>Taper Leg Enclosed Bench (shown with optional 6" high welded caster base and stainless steel top)</p>	WTL200	48"	28"	28"	251.7	\$1226.88	\$1407.66	
	WTL202	60"	28"	28"	264.7	1242.44	1484.16	
	WTL204	72"	28"	28"	277.7	1330.06	1570.90	
	WTL300	48"	28"	34"	269.6	\$1155.66	\$1336.48	
	WTL302	60"	28"	34"	300.4	1173.36	1415.12	
	WTL304	72"	28"	34"	329.4	1263.72	1504.58	
	WTL350	48"	28"	34"	269.6	\$1231.84	\$1412.66	
	WTL352	60"	28"	34"	300.4	1247.40	1489.16	
	WTL354	72"	28"	34"	329.4	1335.06	1575.86	
	For Stainless Steel, add "SS" suffix to part number.							
	Caster Base (welded)							
		11147-000	For 48" wide Taper Leg Enclosed Bench				50.0	\$388.60
		11147-001	For 60" wide Taper Leg Enclosed Bench				55.0	431.78
		11147-002	For 72" wide Taper Leg Enclosed Bench				60.0	474.96

Shop Equipment Units

Work Benches

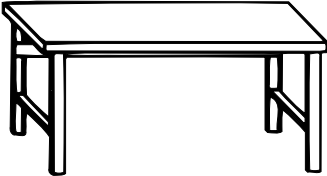
Catalog No.	Size	Wt.	List Price
			
100 Series*			
•WB100	48" x 28"	90.2	\$295.50
WB100SS	48" x 28"	90.2	619.02
•WB101	48" x 34"	100.5	317.06
•WB102	60" x 28"	103.2	320.28
WB102SS	60" x 28"	103.2	722.36
•WB103	60" x 34"	115.6	348.46
•WB104	72" x 28"	116.1	350.16
WB104SS	72" x 28"	116.1	773.90
•WB105	72" x 34"	138.8	375.06

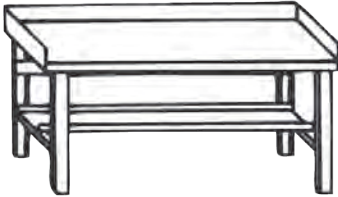
Catalog No.	Size	Wt.	List Price
			
130 Series*			
•WB130	48" x 28"	115.3	\$400.60
WB130SS	48" x 28"	115.3	789.46
•WB131	48" x 34"	126.9	426.54
•WB132	60" x 28"	133.1	428.40
WB132SS	60" x 28"	133.1	936.34
•WB133	60" x 34"	146.7	460.98
•WB134	72" x 28"	151.0	468.52
WB134SS	72" x 28"	151.0	1003.08
•WB135	72" x 34"	166.9	497.78

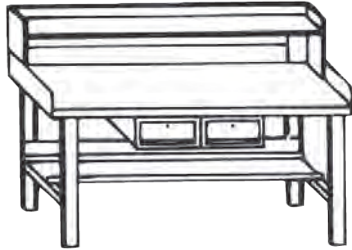
Catalog No.	Size	Wt.	List Price
			
160 Series*			
•WB160	48" x 28"	181.4	\$848.96
•WB161	48" x 34"	197.6	877.34
•WB162	60" x 28"	202.7	877.70
•WB163	60" x 34"	220.9	912.72
•WB164	72" x 28"	224.1	922.96
•WB165	72" x 34"	244.6	954.62

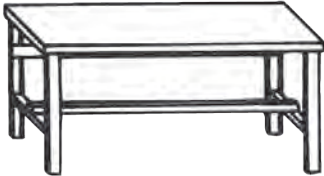
Catalog No.	Size	Wt.	List Price
			
110 Series*			
•WB110	48" x 28"	95.2	\$323.42
•WB111	48" x 34"	105.5	345.02
•WB112	60" x 28"	110.2	351.98
•WB113	60" x 34"	122.6	380.16
•WB114	72" x 28"	123.8	385.08
•WB115	72" x 34"	138.5	409.98

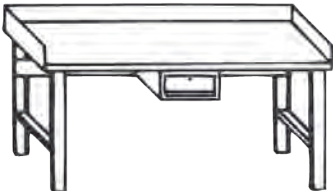
Catalog No.	Size	Wt.	List Price
			
140 Series*			
•WB140	48" x 28"	137.6	\$504.86
•WB141	48" x 34"	151.5	532.04
•WB142	60" x 28"	155.4	529.66
•WB143	60" x 34"	171.3	563.46
•WB144	72" x 28"	173.3	561.32
•WB145	72" x 34"	191.5	591.80

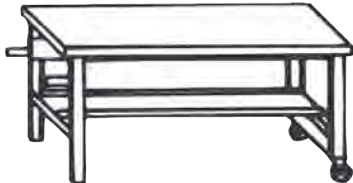
Catalog No.	Size	Wt.	List Price
			
170 Series*			
WB170	48" x 28"	115.4	\$568.72
WB171	48" x 34"	125.7	590.28
WB172	60" x 28"	132.0	596.50
WB173	60" x 34"	144.4	624.68
WB174	72" x 28"	148.6	634.80
WB175	72" x 34"	163.3	659.70

Catalog No.	Size	Wt.	List Price
			
120 Series*			
•WB120	48" x 28"	104.4	\$350.28
WB120SS	48" x 28"	104.4	729.14
•WB121	48" x 34"	114.7	371.86
•WB122	60" x 28"	121.0	378.06
WB122SS	60" x 28"	121.0	792.42
•WB123	60" x 34"	133.4	406.28
•WB124	72" x 28"	137.6	416.40
WB124SS	72" x 28"	137.6	847.46
•WB125	72" x 34"	152.3	441.30

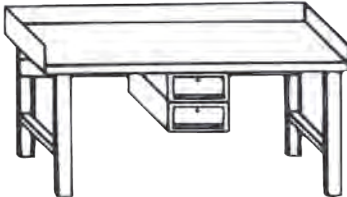
Catalog No.	Size	Wt.	List Price
			
150 Series*			
•WB150	48" x 28"	156.4	\$646.10
•WB151	48" x 34"	170.3	673.24
•WB152	60" x 28"	174.2	670.90
•WB153	60" x 34"	190.1	704.68
•WB154	72" x 28"	192.1	702.54
•WB155	72" x 34"	210.3	733.02

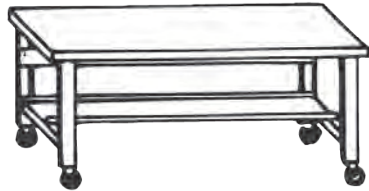
Catalog No.	Size	Wt.	List Price
			
180 Series*			
•WB180	48" x 28"	109.9	\$463.26
•WB181	48" x 34"	120.2	484.82
•WB182	60" x 28"	126.5	491.04
•WB183	60" x 34"	138.9	519.22
•WB184	72" x 28"	143.1	529.38
•WB185	72" x 34"	157.8	554.26

*Height is adjustable from 27-1/2" to 36" on 1" centers.
 SS = Stainless Steel Top
 All units shipped K.D.

Shop Equipment Units

Specialty Benches

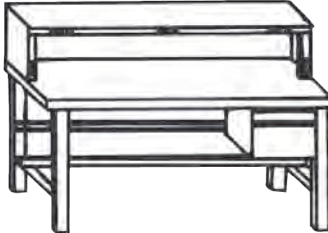
Catalog No.	Size	Wt.	List Price
			
Electronic Bench - 190 Series* (available with static dissipative top only)			
WB190	48" x 28"	180.6	\$1580.06
WB191	48" x 34"	196.7	1586.66
WB192	60" x 28"	206.8	1648.66
WB193	60" x 34"	227.2	1776.38
WB194	72" x 28"	231.5	1788.90
WB195	72" x 34"	256.0	2014.48
NOTE: Electrical outlets and wiring not included			

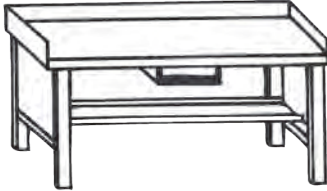
Catalog No.	Size	Wt.	List Price
			
Panel Bench - 220 Series*			
WB220	48" x 28"	153.3	\$680.14
WB221	48" x 34"	167.1	707.28
WB222	60" x 28"	172.4	719.84
WB223	60" x 34"	188.3	753.60
WB224	72" x 28"	191.5	768.88
WB225	72" x 34"	209.7	799.36

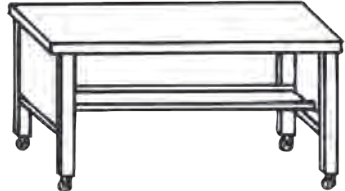
Catalog No.	Size	Wt.	List Price
			
Panel Bench - 250 Series*			
WB250	48" x 28"	125.6	\$583.72
WB251	48" x 34"	135.9	605.28
WB252	60" x 28"	143.5	623.40
WB253	60" x 34"	155.9	651.58
WB254	72" x 28"	161.3	670.68
WB255	72" x 34"	176.0	695.56

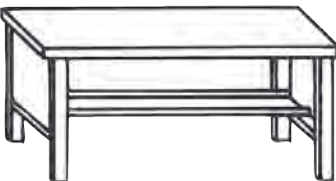
			
Panel Bench - 200 Series*			
WB200	48" x 28"	120.1	\$470.78
WB201	48" x 34"	130.4	492.34
WB202	60" x 28"	138.0	510.42
WB203	60" x 34"	150.4	538.60
WB204	72" x 28"	155.8	557.70
WB205	72" x 34"	170.5	582.60

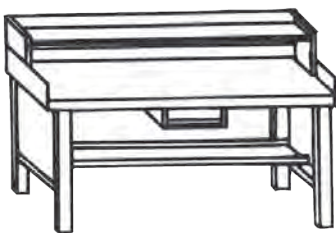
			
Panel Bench - 230 Series*			
WB230	48" x 28"	174.8	\$810.36
WB231	48" x 34"	188.6	837.52
WB232	60" x 28"	197.4	851.00
WB233	60" x 34"	213.3	884.76
WB234	72" x 28"	220.0	905.20
WB235	72" x 34"	238.2	935.68

			
Wall Mount Bench - 300 Series			
•WMB300	48" x 28"	88.2	\$283.30
WMB300SS	48" x 28"	88.2	533.66
•WMB302	60" x 28"	100.2	308.04
WMB302SS	60" x 28"	100.2	637.04
•WMB304	72" x 28"	112.1	337.96
WMB304SS	72" x 28"	112.1	685.86
•WMB305	72" x 34"	126.8	362.80

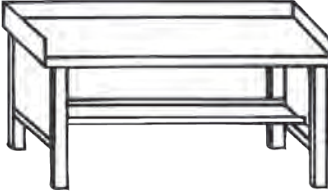
			
Panel Bench - 210 Series*			
WB210	48" x 28"	131.0	\$521.04
WB211	48" x 34"	142.5	547.02
WB212	60" x 28"	150.1	560.74
WB213	60" x 34"	163.7	593.34
WB214	72" x 28"	169.2	609.82
WB215	72" x 34"	185.1	639.10

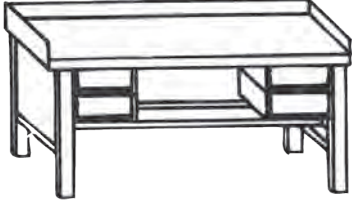
			
Panel Bench - 240 Series*			
WB240	48" x 28"	213.2	\$1121.64
WB241	48" x 34"	229.3	1150.00
WB242	60" x 28"	232.3	1161.34
WB243	60" x 34"	250.5	1196.32
WB244	72" x 28"	251.4	1210.40
WB245	72" x 34"	271.9	1242.10

*Height is adjustable from 27-1/2" to 36" on 1" centers.
 SS = Stainless Steel Top
 All units shipped K.D.

Shop Equipment Units

Modu-Benches

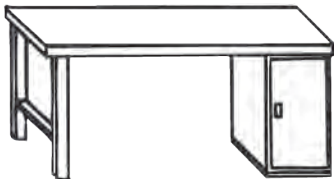
Catalog No.	Size	Wt.	List Price
			
400 Series			
•MB400	48" x 28" x 34"	115.5	\$674.42
•MB401	60" x 28" x 34"	118.5	699.20
•MB402	72" x 28" x 34"	128.5	729.08
•MB406	48" x 28" x 30-3/4"	110.5	603.46
•MB407	60" x 28" x 30-3/4"	113.5	628.24
•MB408	72" x 28" x 30-3/4"	123.5	658.14

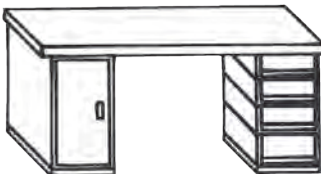
Catalog No.	Size	Wt.	List Price
			
430 Series			
•MB431	60" x 28" x 34"	191.0	\$1272.60
•MB432	72" x 28" x 34"	201.0	1302.48
•MB434	60" x 28" x 30-3/4"	181.0	1148.52
•MB435	72" x 28" x 30-3/4"	191.0	1178.40

			
410 Series			
•MB411	60" x 28" x 34"	146.0	\$1056.54
•MB412	72" x 28" x 34"	156.0	1086.44
•MB414	60" x 28" x 30-3/4"	136.0	914.62
•MB415	72" x 28" x 30-3/4"	146.0	944.52

			
440 Series			
•MB441	60" x 28" x 34"	216.0	\$1471.94
•MB442	72" x 28" x 34"	229.5	1508.72
•MB444	60" x 28" x 30-3/4"	206.0	1330.02
•MB445	72" x 28" x 30-3/4"	219.5	1366.80

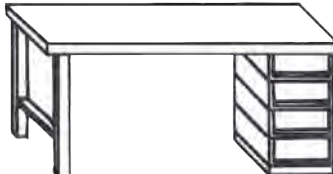
			
420 Series			
•MB420	48" x 28" x 34"	155.5	\$908.30
•MB421	60" x 28" x 34"	163.5	933.08
•MB422	72" x 28" x 34"	173.5	962.96
•MB426	48" x 28" x 30-3/4"	150.5	837.32
•MB427	60" x 28" x 30-3/4"	158.5	862.12
•MB428	72" x 28" x 30-3/4"	168.5	891.98

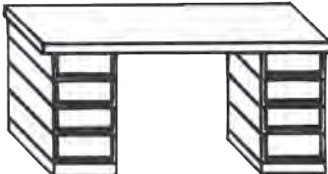
			
450 Series			
•MB451	60" x 28" x 34"	236.0	\$1524.32
•MB452	72" x 28" x 34"	246.0	1554.20
•MB454	60" x 28" x 30-3/4"	226.0	1382.40
•MB455	72" x 28" x 30-3/4"	236.0	1412.28

Please Note

All work benches shown on Pages 55, 56 and 57 (excluding the 190 Series) include a steel top. To order any one of the benches with an optional top, just add the proper suffix to the catalog number, deduct the price of the steel top and add the price of the desired top.

Example:

WB100-MD	\$277.46
- 180.40	
+369.84	
\$466.90	

PW: Pressed Wood on Steel Top
 MT: Edge Grain Hard Maple Top
 MD: Multi-Duty Wood Top
 LT: Laminate Top
 RE: Radius Edge Laminate Top
 SD: Static Dissipative Top

All units shipped K.D.

• InStock in #065 Industrial Gray

Shop Equipment Components

Catalog No.	Size	Wt. Each	Qty. Per Pack	List Price
				
Steel Tops with Stringer*				
•14881-S00	48" x 28" x 1-3/4"	61.0	1	\$192.14
•14881-S01	48" x 34" x 1-3/4"	71.3	1	213.68
•14881-S02	60" x 28" x 1-3/4"	74.0	1	216.90
•14881-S03	60" x 34" x 1-3/4"	86.4	1	245.08
•14881-S04	72" x 28" x 1-3/4"	86.9	1	246.80
•14881-S05	72" x 34" x 1-3/4"	101.6	1	271.68

				
Pressed Wood on Steel with Stringer*				
14883-000	48" x 28" x 2"	69.0	1	\$304.90
14883-001	48" x 34" x 2"	81.0	1	329.80
14883-002	60" x 28" x 2"	83.9	1	339.66
14883-003	60" x 34" x 2"	98.5	1	377.80
14883-004	72" x 28" x 2"	98.9	1	379.52
14883-005	72" x 34" x 2"	116.1	1	406.04

				
Multi-Duty Wood Tops				
00428-062	48" x 28" x 2"	65.2	1	\$393.88
00434-062	48" x 34" x 2"	77.2	1	445.12
00528-062	60" x 28" x 2"	79.1	1	454.70
00534-062	60" x 34" x 2"	93.7	1	510.88
00628-062	72" x 28" x 2"	93.1	1	494.72
00634-062	72" x 34" x 2"	110.3	1	569.96

*Note: Stringer of same size is packed with top.

Catalog No.	Size	Wt. Each	Qty. Per Pack	List Price
				
Solid Maple Tops				
00428-061	48" x 28" x 1-3/4"	64.0	1	\$510.88
00434-061	48" x 34" x 1-3/4"	78.0	1	584.40
00528-061	60" x 28" x 1-3/4"	80.0	1	600.46
00534-061	60" x 34" x 1-3/4"	98.0	1	688.44
00628-061	72" x 28" x 1-3/4"	97.0	1	675.62
00634-061	72" x 34" x 1-3/4"	117.0	1	779.72





				
Laminate Tops				
11020-000	48" x 28" x 1-5/8"	65.3	1	\$249.80
11020-001	48" x 34" x 1-5/8"	79.3	1	272.22
11020-002	60" x 28" x 1-5/8"	81.2	1	277.06
11020-003	60" x 34" x 1-5/8"	99.2	1	312.24
11020-004	72" x 28" x 1-5/8"	98.0	1	312.24
11020-005	72" x 34" x 1-5/8"	119.0	1	349.04





				
Radius Edge Laminate Tops				
11018-000	48" x 28" x 1-3/4"	76.2	1	\$318.64
11018-001	48" x 34" x 1-3/4"	92.3	1	373.06
11018-002	60" x 28" x 1-3/4"	95.2	1	387.30
11018-003	60" x 34" x 1-3/4"	115.8	1	448.32
11018-004	72" x 28" x 1-3/4"	114.4	1	448.32
11018-005	72" x 34" x 1-3/4"	138.9	1	523.58

				
Static Dissipative Tops				
11019-000	48" x 28" x 1-3/4"	76.2	1	\$741.44
11019-001	48" x 34" x 1-3/4"	92.3	1	748.06
11019-002	60" x 28" x 1-3/4"	95.4	1	779.58
11019-003	60" x 34" x 1-3/4"	115.8	1	907.28
11019-004	72" x 28" x 1-3/4"	114.4	1	908.94
11019-005	72" x 34" x 1-3/4"	138.9	1	1134.52

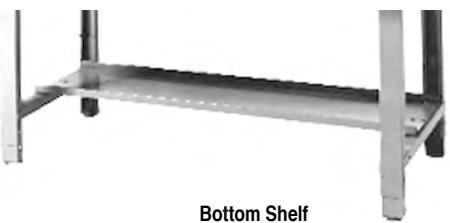
Ground Strap				
11021-000	-	.3	1	\$41.50

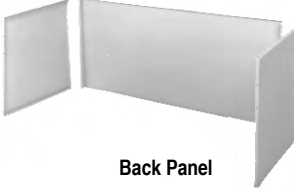
Shop Equipment Components

Catalog No.	Size	Wt. Each	Qty. Per Pack	List Price
 <p>Work Bench Leg (fits all bench tops listed on previous page)</p> <p>•14828-000 27-1/2" to 36"H; 28" and 34"D 14.6 2 \$51.70</p>				
 <p>Leveling Screw (price per pair)</p> <p>14825-000 - .7 12 \$10.78</p> <p>Replacement Adjustable Foot (price each)</p> <p>14809-000 - - 1 \$24.12</p>				
 <p>Wall Mount Leg (price per pair)</p> <p>•11000-000 28" and 34"D 31.0 - \$91.14</p> <p>Leg Attachment Channels</p> <p>14813-000 28" D - - \$23.66 14813-001 34" D - - \$26.44</p>				
<div style="border: 1px solid black; padding: 5px; width: fit-content; margin: 0 auto;"> <p>NOTE: Wood top installation requires addition of leg attachment channels.</p> </div>				
 <p>Stringer</p> <p>•14827-000 48" 3.8 6 \$21.26 •14827-001 60" 4.8 6 24.48 •14827-002 72" 5.8 6 27.86</p>				
 <p>Bottom Shelf</p> <p>•14826-000 48" x 15" 14.2 2 \$54.80 •14826-001 60" x 15" 17.3 2 57.84 •14826-002 72" x 15" 21.5 2 66.26</p>				

Catalog No.	Size	Wt. Each	Qty. Per Pack	List Price
 <p>Foot Rest</p> <p>•14879-000 48" 5.0 4 \$27.98 •14879-001 60" 7.0 4 31.72 •14879-002 72" 7.7 4 34.94</p>				
 <p>Back Panel</p> <p>14853-000 48" x 21" 8.7 2 \$68.12 14853-001 60" x 21" 8.7 2 79.98 14853-002 72" x 21" 8.7 2 88.94</p> <p>End Panel (price per pair)</p> <p>14852-000 28" and 34" 10.8 2 \$52.40</p>				
 <p>Ledge or Top Shelf</p> <p>•14851-000 48" x 10" 21.5 1 \$130.24 •14851-001 60" x 10" 25.0 1 131.20 •14851-002 72" x 10" 28.5 1 136.32</p>				
 <p>Electronic Riser</p> <p>11013-000 48"w x 18"h x 14"d 22.0 1 \$154.30 •11013-001 60"w x 18"h x 14"d 26.0 1 177.78 •11013-002 72"w x 18"h x 14"d 30.0 1 182.04</p> <p>Note: Electrical outlets and wiring not included</p>				
 <p>Electronic Riser Cover Kit</p> <p>11014-000 48" 2.0 - \$91.46 •11014-001 60" 2.4 - 93.70 •11014-002 72" 2.8 - 97.32</p>				
 <p>Back Guard</p> <p>•14824-000 48" 5.1 6 \$28.76 •14824-001 60" 6.3 6 28.78 •14824-002 72" 7.6 6 30.58</p> <p>End Guard (price per pair)</p> <p>•14822-000 28" 5.8 6 \$21.56 •14822-001 34" 7.0 6 25.96</p>				

Shop Equipment Components

Catalog No.	Size	Wt. Each	Qty. Per Pack	List Price
 <p>Semi-Portable Kit</p>				
14854-000	28" and 34"d	11.0/set	1	\$218.44

 <p>Portable Kit</p>				
•14845-000	4" diameter	5.5/set	1	\$112.98

Additional lead time required. Consult factory for details.

 <p>Hanging Drawer Pedestal (includes plunger lock)</p>				
HDP2	15-1/4" x 21-3/4" x 19-1/4"	43.5	1	\$510.24
NOTE: Available in #161 Mist Gray only. Requires Tier Drawer or Hanging Supports when mounting to steel top.				

NOTE: Requires Tier Drawer Supports (see below).

 <p>Tier Drawer</p>				
•14865-000	15-1/4" x 20" x 7-1/4"	18.8	1	\$141.24
•14865-001	21-1/4" x 20" x 7-1/4"	22.4	1	165.14

NOTE: Requires Tier Drawer Supports (see below).

 <p>Tier Drawer Tray</p>				
14880-000	15-1/4"	1.2	10	\$18.40
14880-001	21-1/4"	1.6	10	19.90

 <p>Tier Drawer or Hanging Drawer Pedestal Support (price per pair)</p>				
•14823-000	28"	3.5	6	\$17.86
•14823-001	34"	5.8	6	19.06

Catalog No.	Size	Wt. Each	Qty. Per Pack	List Price
 <p>Tier Drawer / Modu-Cabinet Base</p>				
•14887-000	15-1/4" x 20" x 3-1/4"	5.0	2	\$70.98
14887-001	21-1/4" x 20" x 3-1/4"	6.0	2	81.10

NOTE: Requires Tier Drawer Supports (see below).

 <p>Modu-Drawer Unit</p>				
•MDU15	15-1/4" x 20" x 29"	75.2	1	\$564.90
•MDUB15	15-1/4" x 20" x 32-1/4"	80.2	1	635.84
MDU21	21-1/4" x 20" x 29"	89.6	1	660.58
MDUB21	21-1/4" x 20" x 32-1/4"	95.6	1	741.60

NOTE: Requires Tier Drawer Supports (see below).

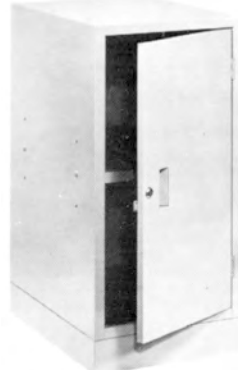
 <p>Modu-Bench Cabinet (base not included)</p>				
•00290-056	15-1/4" x 20" x 29"	35.0	1	\$331.02

 <p>Grooved Key Lock*</p>				
•06594-00	-	.1	1	\$11.18
<p>Padlock Hasp**</p>				
00298-00	-	-	-	\$5.54

*Grooved Key Lock works with Tier Drawers and Modu-Bench Cabinets only
**Padlock Hasp works with Tier Drawers only

Stainless Steel Top Bench Components

Catalog No.	Description	Wt.	List Price
14820-S03-___*	SS Bench Top/Stringer 48" x 28"	61.0	\$473.22
14856-S02-___*	SS Bench Top/Stringer 60" x 28"	74.0	576.66
14857-S02-___*	SS Bench Top/Stringer 72" x 28"	86.0	621.12
14818-003-000	SS Back Guard Assembly 48"	5.1	\$55.64
14818-004-000	SS Back Guard Assembly 60"	6.3	89.70
14818-005-000	SS Back Guard Assembly 72"	7.6	91.04
14822-003-000	SS End Guard Assembly 28"	5.8	\$64.66

***NOTE:**

To order any standard Borroughs open leg workbench with a stainless steel top, use the catalog numbers at left, adding a color suffix. Color must be specified since the stringer is included in the top kit. To calculate the unit price, deduct the price of the original painted steel top and add the price of the stainless steel top.

Shop Equipment Desks and Carts

Catalog No.	Description	Wt.	List Price
			
Shop Desks			
•14804-000	Shop Desk 33"w x 30"d height at front edge 40" includes hinged top and front hinged door	94.0	\$659.78
Cabinet Kit			
00330-055	Cabinet Kit	50.0	\$384.86
00330-048	Casters	2.0/set	\$79.76

Catalog No.	Description	Wt.	List Price
			
Two Shelf Utility Carts - Industrial			
•00160-043	16"w x 30"d x 32"h	45.0	\$342.56
•00240-043	24"w x 36"d x 32"h	66.0	379.06
Extra Shelf			
06707-000	16" x 30" x 3-1/2"	8.0	\$82.16
06721-000	24" x 36" x 3-1/2"	12.0	102.90
Extra Set of Rubber Tread Casters			
00000-044	5" diameter	9.0/set	\$78.82

			
Utility Carts - Commercial (shown with top shelf inverted)			
14432-000	16"w x 30"d x 32"h	26.0	\$245.50
14432-001	24"w x 30"d x 32"h	33.0	260.42

SHOP EQUIPMENT