

Shelving & Display Systems

LIBRARY SHELVING

Storage Solved®

For over thirty years, Spacesaver has been a pioneer in the storage industry, earning forty patents and thousands of satisfied customers along the way. Today, thousands of libraries around the world rely on us for consistent quality, shelf after shelf, frame after frame. Whether school, academic, special, or public, we have the experience to respond creatively and comprehensively to your library's needs. Today, you not only need to shelve media, but also display and merchandise it. We are continually expanding our line of specialty shelves and accessories to keep up with the demands of today – and tomorrow. At some point you may need to reconfigure – that's where Spacesaver Library Shelving products really pay off. Every shelf, frame and accessory is made to the strictest standards to ensure simple reassembly. And since Spacesaver shelving is designed for static and mobile configurations, you can achieve maximum capacity no matter how you arrange your library.

TABLE OF CONTENTS	PAGE
b Bookstack Assemblies / Mobile	4-5
b Divider Type Assemblies / Mobile	6-7
b Bookstack Assemblies / Static	8-9
b Divider Type Assemblies / Static	10-11
b Display Units	12
b Frames & Supports	13-14
b Base Shelves	15
b Adjustable Shelves	15-16
b Specialty Shelves	16-17
b Accessories	18-20
b Options	20-22

Assembly Numbering System

The assembly part numbering system for Spacesaver Cantilever Library Shelving Products describes the individual assembly in detail. This system will simplify your ordering and provide a quick reference to the size of related parts included in an assembly.

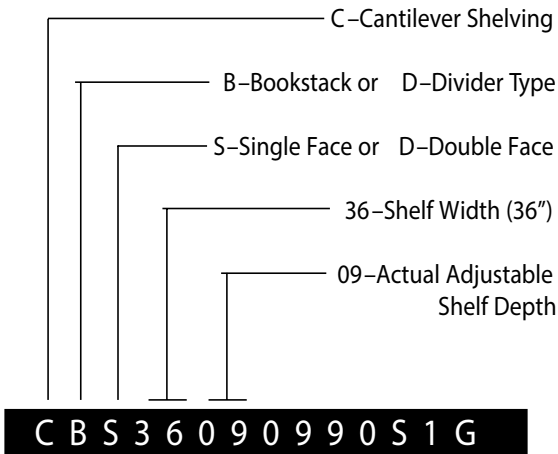

- 09-Actual Base Shelf Depth
- 90-Frame Height (42", 66", 78", 84" or 90")
- S-Starter, A-Adder
- 1-3/4" Base Shelf or 3-3" Base Shelf
- G-Gusseted Assembly

ACTUAL vs. NOMINAL DIMENSIONS
All shelf depth dimensions in the catalog number are actual. For library nominal dimensions, add 1" to the actual depth. See diagram below.

MOBILE GUSSETED UNITS (For use on Spacesaver mobile carriages)

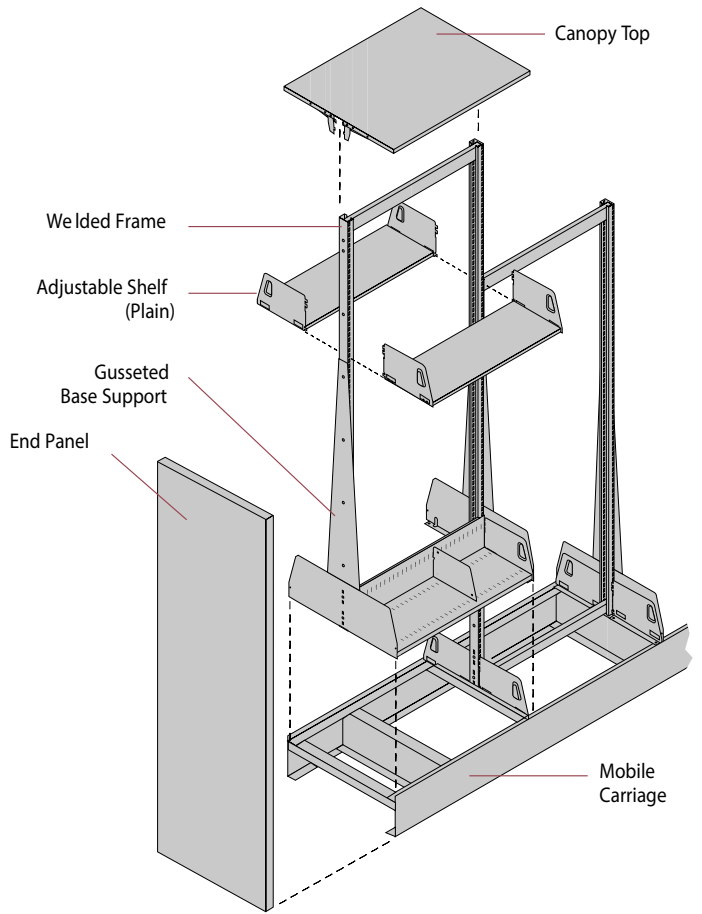

SINGLE FACE & DOUBLE FACE PLAN VIEW DIMENSIONS

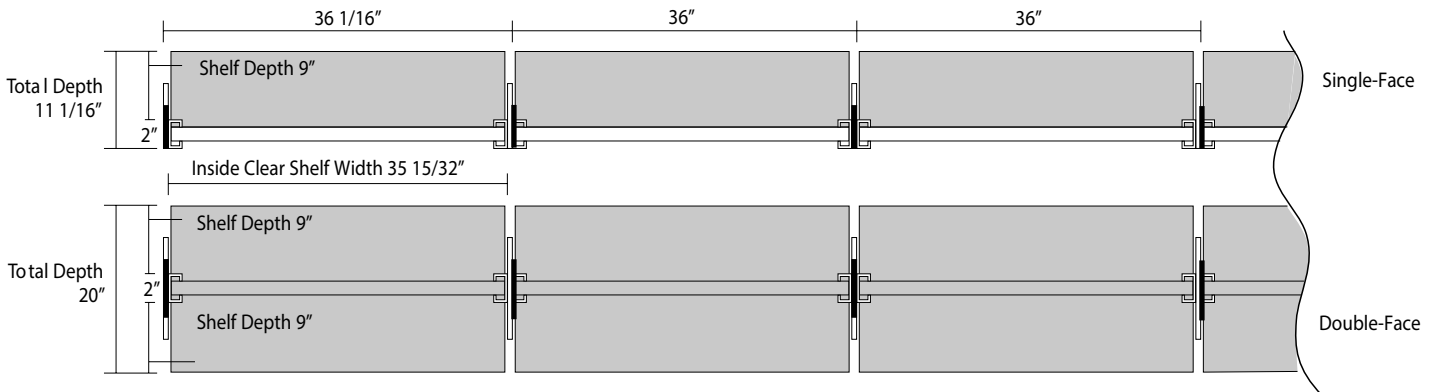

SPACE SAVER
LIBRARY SHELVING

Bookstack Assemblies / Mobile

SINGLE FACE (Starter Assemblies)

OPENINGS	ACTUAL SHELF DEPTH	ACTUAL BASE SHELF DEPTH	OVERALL UNIT DEPTH	CATALOG NO.
78" HIGH				
6	7"	7"	9"	CBS36070778S1G
6	7"	9"	11"	CBS36070978S1G
6	8"	8"	10"	CBS36080878S1G
6	8"	9"	11"	CBS36080978S1G
6	9"	9"	11"	CBS36090978S1G
6	9"	11"	13"	CBS36091178S1G
6	11"	11"	13"	CBS36111178S1G
84" HIGH				
7	7"	7"	9"	CBS36070784S1G
7	7"	9"	11"	CBS36070984S1G
7	8"	8"	10"	CBS36080884S1G
7	8"	9"	11"	CBS36080984S1G
7	9"	9"	11"	CBS36090984S1G
7	9"	11"	13"	CBS36091184S1G
7	11"	11"	13"	CBS36111184S1G
90" HIGH				
7	7"	7"	9"	CBS36070790S1G
7	7"	9"	11"	CBS36070990S1G
7	8"	8"	10"	CBS36080890S1G
7	8"	9"	11"	CBS36080990S1G
7	9"	9"	11"	CBS36090990S1G
7	9"	11"	13"	CBS36091190S1G
7	11"	11"	13"	CBS36111190S1G

SINGLE FACE (Adder Assemblies)

If an Adder Assembly is desired, change the suffix "S" to "A" when ordering, e.g.: CBS36070790A1G.



NOTES:

- Single Face Starter Assemblies include two (2) Gusseted Base Supports, whereas, Single Face Adder Assemblies include one (1) Gusseted Base Support on the right end.
- Assemblies do not include Canopy Top, or Levelers.
- Assemblies only available in 36" widths. If 24" or 30" wide units are desired, this must be done using component catalog numbers.
- For other heights, consult factory.
- All shelf depth dimensions in the catalog number are actual. For library nominal dimension, add 1" to actual depth.
- A II single face units must be anchored to the floor, platform, wall or overhead.
- Includes Base Shelf Filler.



Bookstack Assemblies / Mobile

DOUBLE FACE (Starter Assemblies)

	OPENINGS	ACTUAL SHELF DEPTH	ACTUAL BASE SHELF DEPTH	OVERALL UNIT DEPTH	CATALOG NO.
78" HIGH					
	6	7"	7"	16"	CBD36070778S1G
	6	7"	9"	20"	CBD36070978S1G
	6	8"	8"	18"	CBD36080878S1G
	6	8"	9"	20"	CBD36080978S1G
	6	9"	9"	20"	CBD36090978S1G
	6	9"	11"	24"	CBD36091178S1G
	6	11"	11"	24"	CBD36111178S1G
84" HIGH					
	7	7"	7"	16"	CBD36070784S1G
	7	7"	9"	20"	CBD36070984S1G
	7	8"	8"	18"	CBD36080884S1G
	7	8"	9"	20"	CBD36080984S1G
	7	9"	9"	20"	CBD36090984S1G
	7	9"	11"	24"	CBD36091184S1G
	7	11"	11"	24"	CBD36111184S1G
90" HIGH					
	7	7"	7"	16"	CBD36070790S1G
	7	7"	9"	20"	CBD36070990S1G
	7	8"	8"	18"	CBD36080890S1G
	7	8"	9"	20"	CBD36080990S1G
	7	9"	9"	20"	CBD36090990S1G
	7	9"	11"	24"	CBD36091190S1G
	7	11"	11"	24"	CBD36111190S1G



DOUBLE FACE (Adder Assemblies)

If an Adder Assembly is desired, change the suffix "S" to "A" when ordering, e.g.: CBD36070990A1G.

NOTES:

- Double Face Starter Assemblies include two (2) Gusseted Base Supports, whereas, Double Face Adder Assemblies include one (1) Gusseted Base Support on the right end.
- Assemblies only available in 36" widths. If 24" or 30" wide units are desired, this must be done using component catalog numbers.
- For other heights, consult factory.
- All shelf depth dimensions in the catalog number are actual. For library nominal dimension, add 1" to actual depth.
- Assemblies do not include Canopy Top, or Levelers.
- Includes Base Shelf Filler.

SPACESAVER
LIBRARY SHELVING

Divider-Type Assemblies / Mobile

SINGLE FACE (Starter Assemblies)

OPENINGS	ACTUAL SHELF DEPTH	ACTUAL BASE SHELF DEPTH	OVERALL UNIT DEPTH	CATALOG NO.
78" HIGH				
6	9"	9"	11"	CDS36090978S1G
6	9"	11"	13"	CDS36091178S1G
6	9"	12"	14"	CDS36091278S1G
6	10"	10"	12"	CDS36101078S1G
6	11"	11"	13"	CDS36111178S1G
6	12"	12"	14"	CDS36121278S1G
6	12"	15"	17"	CDS36121578S1G
6	15"	15"	17"	CDS36151578S1G
84" HIGH				
7	9"	9"	11"	CDS36090984S1G
7	9"	11"	13"	CDS36091184S1G
7	9"	12"	14"	CDS36091284S1G
7	10"	10"	12"	CDS36101084S1G
7	11"	11"	13"	CDS36111184S1G
7	12"	12"	14"	CDS36121284S1G
7	12"	15"	17"	CDS36121584S1G
7	15"	15"	17"	CDS36151584S1G
90" HIGH				
7	9"	9"	11"	CDS36090990S1G
7	9"	11"	13"	CDS36091190S1G
7	9"	12"	14"	CDS36091290S1G
7	10"	10"	12"	CDS36101090S1G
7	11"	11"	13"	CDS36111190S1G
7	12"	12"	14"	CDS36121290S1G
7	12"	15"	17"	CDS36121590S1G
7	15"	15"	17"	CDS36151590S1G

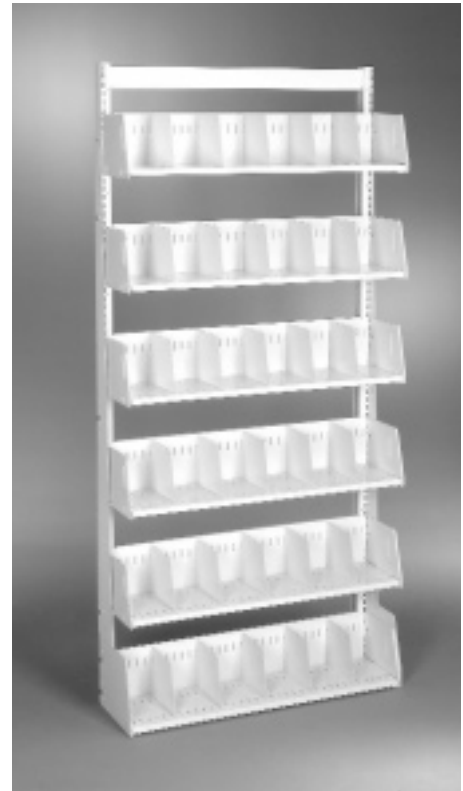

SINGLE FACE (Starter Assemblies)

If an Adder Assembly is desired, change the suffix "S" to "A" when ordering, e.g.: CDS36121584A1G.

NOTES:

- Divider-type Assemblies include five (5) Dividers per shelf.
- Single Face Starter Assemblies include two (2) Gusseted Base Supports, whereas, Single Face Adder Assemblies include one (1) Gusseted Base Support on the right end.
- Assemblies only available in 36" widths. If 24" or 30" wide units are desired, this must be done using component catalog numbers.
- For other heights, consult factory.
- All shelf depth dimensions in the catalog number are actual. For library nominal dimension, add 1" to actual depth.
- Assemblies do not include Canopy Top, or Levelers.
- All single face units must be anchored to the floor, platform, wall or overhead.
- Includes Base Shelf Filler.

Divider-Type Assemblies / Mobile

DOUBLE FACE (Starter Assemblies)

OPENINGS	ACTUAL SHELF DEPTH	ACTUAL BASE SHELF DEPTH	OVERALL UNIT DEPTH	CATALOG NO.
78" HIGH				
6	9"	9"	20"	CDD36090978S1G
6	9"	11"	24"	CDD36091178S1G
6	9"	12"	26"	CDD36091278S1G
6	10"	10"	22"	CDD36101078S1G
6	11"	11"	24"	CDD36111178S1G
6	12"	12"	26"	CDD36121278S1G
6	12"	15"	32"	CDD36121578S1G
6	15"	15"	32"	CDD36151578S1G
84" HIGH				
7	9"	9"	20"	CDD36090984S1G
7	9"	11"	24"	CDD36091184S1G
7	9"	12"	26"	CDD36091284S1G
7	10"	10"	22"	CDD36101084S1G
7	11"	11"	26"	CDD36111184S1G
7	12"	12"	26"	CDD36121284S1G
7	12"	15"	32"	CDD36121584S1G
7	15"	15"	32"	CDD36151584S1G
90" HIGH				
7	9"	9"	20"	CDD36090990S1G
7	9"	11"	24"	CDD36091190S1G
7	9"	12"	26"	CDD36091290S1G
7	10"	10"	22"	CDD36101090S1G
7	11"	11"	24"	CDD36111190S1G
7	12"	12"	26"	CDD36121290S1G
7	12"	15"	32"	CDD36121590S1G
7	15"	15"	32"	CDD36151590S1G

DOUBLE FACE (Adder Assemblies)

If an Adder Assembly is desired, change the suffix "S" to "A" when ordering, e.g.: CDD36121584A1G.

NOTES:

- Divider-type Assemblies include five (5) Dividers per shelf.
- Double Face Starter Assemblies include two (2) Gusseted Base Supports, whereas, Double Face Adder Assemblies include one (1) Gusseted Base Support on the right end.
- Assemblies only available in 36" widths. If 24" or 30" wide units are desired, this must be done using component catalog numbers.
- For other heights, consult factory.
- A II shelf depth dimensions in the catalog number are actual. For library nominal dimension, add 1" to actual depth.
- Assemblies do not include Canopy Top, or Levelers.
- Includes Base Shelf Filler.



SPACE SAVER
LIBRARY SHELVING

Bookstack Assemblies / Static

SINGLE FACE (Starter Assemblies)

OPENINGS	ACTUAL SHELF DEPTH	ACTUAL BASE SHELF DEPTH	OVERALL UNIT DEPTH	CATALOG NO.
42" High				
3	7"	7"	9"	CBS36070742S3
3	7"	9"	11"	CBS36070942S3
3	8"	8"	10"	CBS36080842S3
3	8"	9"	11"	CBS36080942S3
3	9"	9"	11"	CBS36090942S3
3	9"	11"	13"	CBS36091142S3
3	11"	11"	13"	CBS36111142S3
66" HIGH				
5	7"	7"	9"	CBS36070766S3
5	7"	9"	11"	CBS36070966S3
5	8"	8"	10"	CBS36080866S3
5	8"	9"	11"	CBS36080966S3
5	9"	9"	11"	CBS36090966S3
5	9"	11"	13"	CBS36091166S3
5	11"	11"	13"	CBS36111166S3
78" HIGH				
6	7"	7"	9"	CBS36070778S3
6	7"	9"	11"	CBS36070978S3
6	8"	8"	10"	CBS36080878S3
6	8"	9"	11"	CBS36080978S3
6	9"	9"	11"	CBS36090978S3
6	9"	11"	13"	CBS36091178S3
6	11"	11"	13"	CBS36111178S3
84" HIGH				
7	7"	7"	9"	CBS36070784S3
7	7"	9"	11"	CBS36070984S3
7	8"	8"	10"	CBS36080884S3
7	8"	9"	11"	CBS36080984S3
7	9"	9"	11"	CBS36090984S3
7	9"	11"	13"	CBS36091184S3
7	11"	11"	13"	CBS36111184S3
90" HIGH				
7	7"	7"	9"	CBS36070790S3
7	7"	9"	11"	CBS36070990S3
7	8"	8"	10"	CBS36080890S3
7	8"	9"	11"	CBS36080990S3
7	9"	9"	11"	CBS36090990S3
7	9"	11"	13"	CBS36091190S3
7	11"	11"	13"	CBS36111190S3



SINGLE FACE (Starter Assemblies)

If an Adder Assembly is desired, change the suffix "S" to "A" when ordering, e.g.: CBS36091184A3.

NOTES:

- Single Face Starter Assemblies include two (2) Base Supports, whereas, Single Face Adder Assemblies include one (1) Base Support on the right end.
- Assemblies do not include Canopy Top, or Levelers.
- All single face units must be anchored to the floor, wall or overhead.
- A ssemblies only available in 36" widths. If 24" or 30" wide units are desired, this must be done using component catalog numbers.
- For other heights, consult factory.
- A ll shelf depth dimensions in the catalog number are actual. For library nominal dimension, add 1" to actual depth.
- Includes Base Shelf Filler.

Bookstack Assemblies / Static

DOUBLE FACE (Starter Assemblies)

OPENINGS	ACTUAL SHELF DEPTH	ACTUAL BASE SHELF DEPTH	OVERALL UNIT DEPTH	CATALOG NO.
42" HIGH				
3	7"	7"	16"	CBD36070742S3
3	7"	9"	20"	CBD36070942S3
3	8"	8"	18"	CBD36080842S3
3	8"	9"	20"	CBD36080942S3
3	9"	9"	20"	CBD36090942S3
3	9"	11"	24"	CBD36091142S3
3	11"	11"	24"	CBD36111142S3
66" HIGH				
5	7"	7"	16"	CBD36070766S3
5	7"	9"	20"	CBD36070966S3
5	8"	8"	18"	CBD36080866S3
5	8"	9"	20"	CBD36080966S3
5	9"	9"	20"	CBD36090966S3
5	9"	11"	24"	CBD36091166S3
5	11"	11"	24"	CBD36111166S3
78" HIGH				
6	7"	7"	16"	CBD36070778S3
6	7"	9"	20"	CBD36070978S3
6	8"	8"	18"	CBD36080878S3
6	8"	9"	20"	CBD36080978S3
6	9"	9"	20"	CBD36090978S3
6	9"	11"	24"	CBD36091178S3
6	11"	11"	24"	CBD36111178S3
84" HIGH				
7	7"	7"	16"	CBD36070784S3
7	7"	9"	20"	CBD36070984S3
7	8"	8"	18"	CBD36080884S3
7	8"	9"	20"	CBD36080984S3
7	9"	9"	20"	CBD36090984S3
7	9"	11"	24"	CBD36091184S3
7	11"	11"	24"	CBD36111184S3
90" HIGH				
7	7"	7"	16"	CBD36070790S3
7	7"	9"	20"	CBD36070990S3
7	8"	8"	18"	CBD36080890S3
7	8"	9"	20"	CBD36080990S3
7	9"	9"	20"	CBD36090990S3
7	9"	11"	24"	CBD36091190S3
7	11"	11"	24"	CBD36111190S3

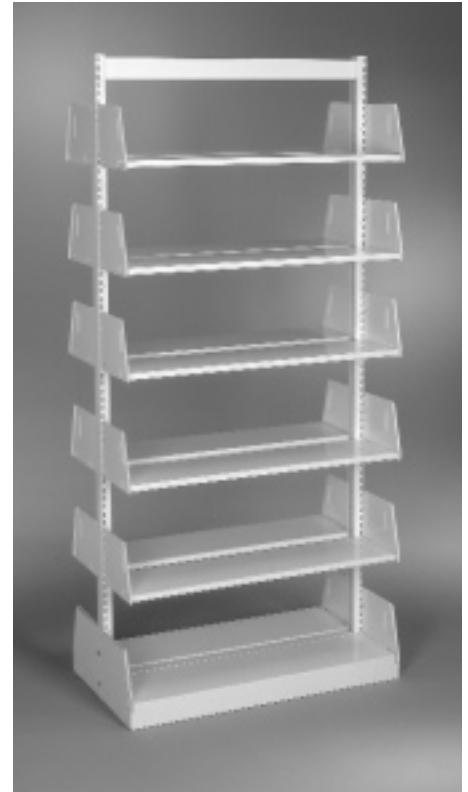

DOUBLE FACE (Adder Assemblies)

If an Adder Assembly is desired, change the suffix "S" to "A" when ordering, e.g.: CBD36070990A3.

NOTES:

- Double Face Starter Assemblies include two (2) Base Supports, whereas, Double Face Adder Assemblies include one (1) Base Support on the right end.
- It is recommended that all units over 78" tall be anchored to the floor or overhead (per local codes and/or requirements).
- Assemblies only available in 36" widths. If 24" or 30" wide units are desired, this must be done using component catalog numbers.
- For other heights, consult factory.
- A // shelf depth dimensions in the catalog number are actual. For library nominal dimension, add 1" to actual depth.
- Includes Base Shelf Filler.
- Assemblies do not include Canopy Top, or Levelers.

SPACE SAVER
LIBRARY SHELVING

Divider-Type Assemblies / Static

SINGLE FACE (Starter Assemblies)

OPENINGS	ACTUAL SHELF DEPTH	ACTUAL BASE SHELF DEPTH	OVERALL UNIT DEPTH	CATALOG NO.
42" HIGH				
3	9"	9"	11"	CDS36090942S3
3	9"	11"	13"	CDS36091142S3
3	9"	12"	14"	CDS36091242S3
3	10"	10"	12"	CDS36101042S3
3	11"	11"	13"	CDS36111142S3
3	12"	12"	14"	CDS36121242S3
3	12"	15"	17"	CDS36121542S3
3	15"	15"	17"	CDS36151542S3
66" HIGH				
5	9"	9"	11"	CDS36090966S3
5	9"	11"	13"	CDS36091166S3
5	9"	12"	14"	CDS36091266S3
5	10"	10"	12"	CDS36101066S3
5	11"	11"	13"	CDS36111166S3
5	12"	12"	14"	CDS36121266S3
5	12"	15"	17"	CDS36121566S3
5	15"	15"	17"	CDS36151566S3
78" HIGH				
6	9"	9"	11"	CDS36090978S3
6	9"	11"	13"	CDS36091178S3
6	9"	12"	14"	CDS36091278S3
6	10"	10"	12"	CDS36101078S3
6	11"	11"	13"	CDS36111178S3
6	12"	12"	14"	CDS36121278S3
6	12"	15"	17"	CDS36121578S3
6	15"	15"	17"	CDS36151578S3
84" HIGH				
7	9"	9"	11"	CDS36090984S3
7	9"	11"	13"	CDS36091184S3
7	9"	12"	14"	CDS36091284S3
7	10"	10"	12"	CDS36101084S3
7	11"	11"	13"	CDS36111184S3
7	12"	12"	14"	CDS36121284S3
7	12"	15"	17"	CDS36121584S3
7	15"	15"	17"	CDS36151584S3
90" HIGH				
7	9"	9"	11"	CDS36090990S3
7	9"	11"	13"	CDS36091190S3
7	9"	12"	14"	CDS36091290S3
7	10"	10"	12"	CDS36101090S3
7	11"	11"	13"	CDS36111190S3
7	12"	12"	14"	CDS36121290S3
7	12"	15"	17"	CDS36121590S3
7	15"	15"	17"	CDS36151590S3



SINGLE FACE (Adder Assemblies)

If an Adder Assembly is desired, change the suffix "S" to "A" when ordering, e.g.: CDS36121584A3.

NOTES:

- Divider-type Assemblies include five (5) Dividers per shelf.
- Single Face Starter Assemblies include two (2) Base Supports, whereas, Single Face Adder Assemblies include one (1) Base Support on the right end.
- All Single Face units must be anchored to the floor, wall or overhead.
- Assemblies only available in 36" widths. If 24" or 30" wide units are desired, this must be done using component catalog numbers.
- For other heights, consult factory.
- All shelf depth dimensions in the catalog number are actual. For library nominal dimension, add 1" to actual depth.
- Assemblies do not include Canopy Top, or Levelers.

Divider-Type Assemblies / Static

DOUBLE FACE (Starter Assemblies)

OPENINGS	ACTUAL SHELF DEPTH	ACTUAL BASE SHELF DEPTH	OVERALL UNIT DEPTH	CATALOG NO.
42" HIGH				
3	9"	9"	20"	CDD36090942S3
3	9"	11"	24"	CDD36091142S3
3	9"	12"	26"	CDD36091242S3
3	10"	10"	22"	CDD36101042S3
3	11"	11"	24"	CDD36111142S3
3	12"	12"	26"	CDD36121242S3
3	12"	15"	32"	CDD36121542S3
3	15"	15"	32"	CDD36151542S3
66" HIGH				
5	9"	9"	20"	CDD36090966S3
5	9"	11"	24"	CDD36091166S3
5	9"	12"	26"	CDD36091266S3
5	10"	10"	22"	CDD36101066S3
5	11"	11"	24"	CDD36111166S3
5	12"	12"	26"	CDD36121266S3
5	12"	15"	32"	CDD36121566S3
5	15"	15"	32"	CDD36151566S3
78" HIGH				
6	9"	9"	20"	CDD36090978S3
6	9"	11"	24"	CDD36091178S3
6	9"	12"	26"	CDD36091278S3
6	10"	10"	22"	CDD36101078S3
6	11"	11"	24"	CDD36111178S3
6	12"	12"	26"	CDD36121278S3
6	12"	15"	32"	CDD36121578S3
6	15"	15"	32"	CDD36151578S3
84" HIGH				
7	9"	9"	20"	CDD36090984S3
7	9"	11"	24"	CDD36091184S3
7	9"	12"	26"	CDD36091284S3
7	10"	10"	22"	CDD36101084S3
7	11"	11"	26"	CDD36111184S3
7	12"	12"	26"	CDD36121284S3
7	12"	15"	32"	CDD36121584S3
7	15"	15"	32"	CDD36151584S3
90" HIGH				
7	9"	9"	20"	CDD36090990S3
7	9"	11"	24"	CDD36091190S3
7	9"	12"	26"	CDD36091290S3
7	10"	10"	22"	CDD36101090S3
7	11"	11"	24"	CDD36111190S3
7	12"	12"	26"	CDD36121290S3
7	12"	15"	32"	CDD36121590S3
7	15"	15"	32"	CDD36151590S3



DOUBLE FACE (Adder Assemblies)

If an Adder Assembly is desired, change the suffix "S" to "A" when ordering, e.g.: CDD36121584A3.

NOTES:

- Divider-type Assemblies include five (5) Dividers per shelf.
- Double Face Starter Assemblies include two (2) Base Supports, whereas, Double Face Adder Assemblies include one (1) Base Support on the right end.
- It is recommended that all units over 78" tall be anchored to the floor or overhead (per local codes and/or requirements).
- Assemblies only available in 36" widths. If 24" or 30" wide units are desired, this must be done using component catalog numbers.
- For other heights, consult factory.
- All shelf depth dimensions in the catalog number are actual. For library nominal dimension, add 1" to actual depth.
- Assemblies do not include Canopy Top, or Levelers.
- Includes Base Shelf Filler.

SPACE SAVER
LIBRARY SHELVING

Display Units

PERIODICAL DISPLAY & STORAGE UNITS (with Hinged Display Shelves)

Sloped 14" hinged display shelves combined with flat 12" storage shelves.

SINGLE FACE (Starter Assemblies)

HEIGHT	DISPLAY SHELVES	STORAGE SHELVES	OVERALL UNIT DEPTH	CATALOG NO.
66"	4	4	15-1/4	CHPS361466S3
78"	5	5	15-1/4	CHPS361478S3
84"	5	5	15-1/4	CHPS361484S3
90"	6	6	15-1/4	CHPS361490S3

DOUBLE FACE (Starter Assemblies)

HEIGHT	DISPLAY SHELVES	STORAGE SHELVES	OVERALL UNIT DEPTH	CATALOG NO.
66"	8	8	28-1/2	CHPD361466S3
78"	10	10	28-1/2	CHPD361478S3
84"	10	10	28-1/2	CHPD361484S3
90"	12	12	28-1/2	CHPD361490S3

SINGLE & DOUBLE FACE (Adder Assemblies)

If an Adder Assembly unit is desired, change the suffix "S" to "A" when ordering, e.g.: CHPS361466A3.

NOTES:

- The vertical opening between the flat shelf and the hinged display shelf (in the open position) is 6" clear.
- When 24" or 30" wide units are desired, please order using component catalog numbers.
- If End Panels are used, consult factory for End Panel width dimension.
- Includes Base Shelf Filler.



SLOPING DISPLAY UNITS

For merchandising assorted media (i.e., best sellers, tapes, etc.).
Shelves are 8" deep actual.

SINGLE FACE (Starter Assemblies)

HEIGHT	LEVEL SHELVES	SLOPED SHELVES	CATALOG NO.
42"	0	3	CSDS360842S
66"	2	3	CSDS360866S
84"	3	4	CSDS360884S
90"	3	4	CSDS360890S

DOUBLE FACE (Starter Assemblies)

HEIGHT	LEVEL SHELVES	SLOPED SHELVES	CATALOG NO.
42"	0	6	CSDD360842S
66"	4	6	CSDD360866S
84"	6	8	CSDD360884S
90"	6	8	CSDD360890S

SINGLE & DOUBLE FACE (Adder Assemblies)

If an Adder Assembly is desired, change the suffix "S" to "A" when ordering, e.g.: CSDS360866A.

NOTE:

- If End Panels are used, consult factory for End Panel width dimension.

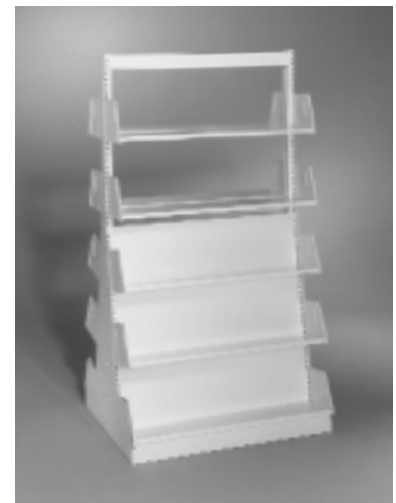

WELDED FRAMES

Accepts all shelves and accessory items. Adjustable on 1" increments.
No sway braces to inhibit oversized media from passing center line of bookstack.

FRAME HEIGHT	CATALOG NUMBER*
42"	CWF-4236
66"	CWF-6636
78"	CWF-7836
84"	CWF-8436
90"	CWF-9036

NOTES:

- *24" or 30" widths are available. Change the catalog number accordingly, e.g.: CWF-8430.
- Consult factory for special heights.

SEISMIC WELDED FRAMES

Accepts all shelves and accessory items. Adjustable on 1" increments.
May be adapted to meet all seismic requirements.*

FRAME HEIGHT	CATALOG NUMBER**
78"	CWF3-7836
84"	CWF3-8436
90"	CWF3-9036

NOTES:

- *Additional horizontal spreaders available.
- **24" and 30" widths are available. Change the catalog number accordingly, e.g.: CWF3-8430.
- Special heights available.

BASE SUPPORTS

Single face Base Supports must be specified left or right.

S I N G L E F A C E

OVERALL SUPPORT DEPTH	LEFT END CATALOG NO.*	RIGHT END CATALOG NO.*
8"	CSB-6L	CSB-6R
9"	CSB-7L	CSB-7R
10"	CSB-8L	CSB-8R
11"	CSB-9L	CSB-9R
12"	CSB-10L	CSB-10R
13"	CSB-11L	CSB-11R
14"	CSB-12L	CSB-12R
16"	CSB-14L	CSB-14R
17"	CSB-15L	CSB-15R

D O U B L E F A C E

OVERALL SUPPORT DEPTH	CATALOG NO.*
14"	CDB-6
16"	CDB-7
18"	CDB-8
20"	CDB-9
22"	CDB-10
24"	CDB-11
26"	CDB-12
30"*	CDB-14
32"	CDB-15

*For use only with CVCD3615DT Shelf.

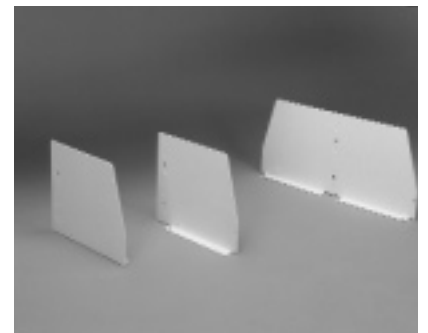
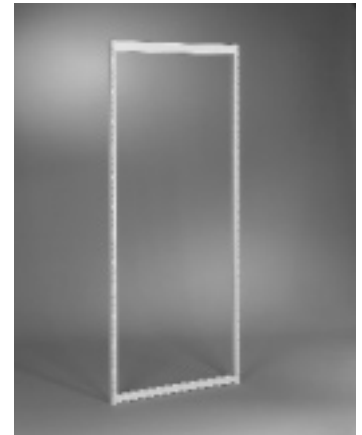

NOTE:

- *Catalog number corresponds to actual depth of Base Shelf used.

SPACESAVER
LIBRARY SHELVING

Frames and Supports (continued)

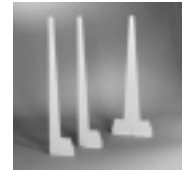

GUSSETED BASE SUPPORTS

For use in seismic and/or mobile shelving applications. Specify Single Face Base Supports left or right.

SINGLE FACE: 70" THRU 90" HIGH FRAMES

OVERALL SUPPORT DEPTH	LEFT END CATALOG NO.*	RIGHT END CATALOG NO.*
8"	CSBG-6L	CSBG-6R
9"	CSBG-7L	CSBG-7R
10"	CSBG-8L	CSBG-8R
11"	CSBG-9L	CSBG-9R
12"	CSBG-10L	CSBG-10R
13"	CSBG-11L	CSBG-11R
14"	CSBG-12L	CSBG-12R
17"	CSBG-15L	CSBG-15R

DOUBLE FACE: 70" THRU 90" HIGH FRAMES

OVERALL SUPPORT DEPTH	CATALOG NO.*
14"	CDBG-6
16"	CDBG-7
18"	CDBG-8
20"	CDBG-9
22"	CDBG-10
24"	CDBG-11
26"	CDBG-12
32"	CDBG-15

SINGLE FACE: 46" THRU 57" HIGH FRAMES

OVERALL SUPPORT DEPTH	LEFT END CATALOG NO.*	RIGHT END CATALOG NO.*
8"	CSBG-6L46	CSBG-6R46
9"	CSBG-7L46	CSBG-7R46
10"	CSBG-8L46	CSBG-8R46
11"	CSBG-9L46	CSBG-9R46
12"	CSBG-10L46	CSBG-10R46
13"	CSBG-11L46	CSBG-11R46
14"	CSBG-12L46	CSBG-12R46
17"	CSBG-15L46	CSBG-15R46

DOUBLE FACE: 46" THRU 57" HIGH FRAMES

OVERALL SUPPORT DEPTH	CATALOG NO.*
14"	CDBG-646
16"	CDBG-746
18"	CDBG-846
20"	CDBG-946
22"	CDBG-1046
24"	CDBG-1146
26"	CDBG-1246
32"	CDBG-1546

SINGLE FACE: 58" THRU 69" HIGH FRAMES

OVERALL SUPPORT DEPTH	LEFT END CATALOG NO.*	RIGHT END CATALOG NO.*
8"	CSBG-6L58	CSBG-6R58
9"	CSBG-7L58	CSBG-7R58
10"	CSBG-8L58	CSBG-8R58
11"	CSBG-9L58	CSBG-9R58
12"	CSBG-10L58	CSBG-10R58
13"	CSBG-11L58	CSBG-11R58
14"	CSBG-12L58	CSBG-12R58
17"	CSBG-15L58	CSBG-15R58

DOUBLE FACE: 58" THRU 69" HIGH FRAMES

OVERALL SUPPORT DEPTH	CATALOG NO.*
14"	CDBG-658
16"	CDBG-758
18"	CDBG-858
20"	CDBG-958
22"	CDBG-1058
24"	CDBG-1158
26"	CDBG-1258
32"	CDBG-1558

NOTE:

- *Catalog number corresponds to actual depth of Base Shelf used.

TRANSVERSE OVERHEAD TIE STRUTS

For extra stabilization overhead when local conditions require.

STRUT LENGTH	CATALOG NO.
96"	CTTS-96
120"	CTTS-120
WALL ANCHOR BRACKET*	CTSWA
SPLICE KIT*	CTTS-SK



NOTE:

- *Includes hardware.

WALL COLUMN SUPPORTS

All shelves and accessory components can easily be attached to Wall Column Supports for wall-mounted installations*. Column width and depth: 2³/₄" wide x 3³/₄" deep.

COLUMN HEIGHT	CATALOG NO.
42"	CWFC-42
66"	CWFC-66
78"	CWFC-78
84"	CWFC-84
90"	CWFC-90

NOTES:

- * If Canopy Tops are desired for use with Wall Column Supports, consult factory.
- Special heights available.
- Recommended for concrete or brick walls. To be anchored with the appropriate hardware supplied by the installer for the specific wall material.



Base Shelves / Adjustable Shelves

3" BASE SHELVES*

ACTUAL SHELF DEPTH	CATALOG NO.
6"	CBSPB-3606
7"	CBSPB-3607
8"	CBSPB-3608
9"	CBSPB-3609
10"	CBSPB-3610
11"	CBSPB-3611
12"	CBSPB-3612
15"	CBSPB-3615

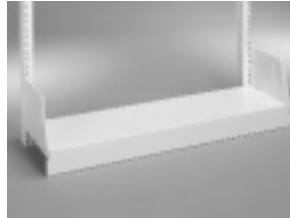

3" Base Shelves position media clear of brooms and floor mops.

3" SLOPED PLAIN BASE SHELVES*

ACTUAL SHELF DEPTH	CATALOG NO.
6"	CBSPB-3606SL
7"	CBSPB-3607SL
8"	CBSPB-3608SL
9"	CBSPB-3609SL
10"	CBSPB-3610SL
11"	CBSPB-3611SL
12"	CBSPB-3612SL
15"	CBSPB-3615SL

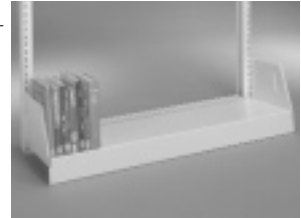

Sloped to aid viewing of items on the bottom shelf.

NOTE:

- If End Panels are used with Sloped Base Shelf, consult factory for End Panel dimension.

3" BASE SHELVES WITH INTEGRAL LOW-BACK*

ACTUAL SHELF DEPTH	CATALOG NO.
6"	CLBBSB-3606
7"	CLBBSB-3607
8"	CLBBSB-3608
9"	CLBBSB-3609
10"	CLBBSB-3610
11"	CLBBSB-3611
12"	CLBBSB-3612
15"	CLBBSB-3615

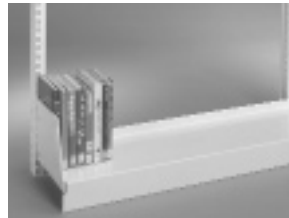

Integral Low-Back Shelves are compatible with Integral Low-Back Dividers.

NOTE:

- 1 Integral Low-Back Dividers (Catalog No. CLBDxx) sold separately. See page 19 for corresponding Integral Low-Back Dividers.

3" SLOPED BASE SHELVES WITH INTEGRAL LOW-BACK*

ACTUAL SHELF DEPTH	CATALOG NO.
6"	CLBBSB-3606SL
7"	CLBBSB-3607SL
8"	CLBBSB-3608SL
9"	CLBBSB-3609SL
10"	CLBBSB-3610SL
11"	CLBBSB-3611SL
12"	CLBBSB-3612SL
15"	CLBBSB-3615SL

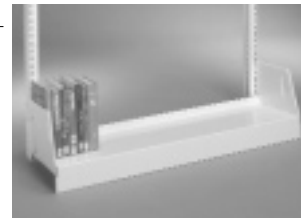

Sloped to aid viewing of items on the bottom shelf. Integral Low-Back Shelves are compatible with Integral Low-Back Dividers.

NOTE:

- Integral Low-Back Dividers (Catalog No. CLBDxx) sold separately. See page 19 for corresponding Integral Low-Back Dividers.
- If End Panels are used with Sloped Base Shelf, consult factory for End Panel dimension.

3" SLOTTED BASE SHELVES*

ACTUAL SHELF DEPTH	CATALOG NO.
6"	CBSSB-3606
7"	CBSSB-3607
8"	CBSSB-3608
9"	CBSSB-3609
10"	CBSSB-3610
11"	CBSSB-3611
12"	CBSSB-3612
15"	CBSSB-3615

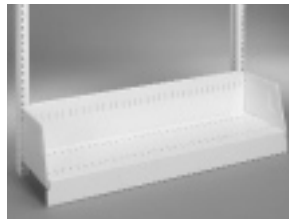

Slotted on 1" centers for Dividers. Includes Slotted Backstop.

NOTE:

- Dividers sold separately. See page 18.

* Base Shelves include End Brackets. Standard widths of 36", 24" and 30" are available. Change the catalog number accordingly, e.g., CBSPB-2411. If 1" nominal "Base Shelves" are desired, see below for Adjustable Shelves.

3" SLOPED SLOTTED BASE SHELVES*

ACTUAL SHELF DEPTH	CATALOG NO.
6"	CBSSB-3606SL
7"	CBSSB-3607SL
8"	CBSSB-3608SL
9"	CBSSB-3609SL
10"	CBSSB-3610SL
11"	CBSSB-3611SL
12"	CBSSB-3612SL
15"	CBSSB-3615SL

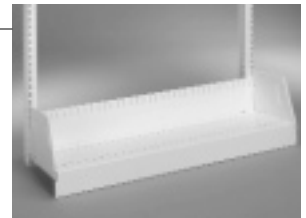

Slotted on 1" centers for Dividers. Sloped to aid viewing of items on the bottom shelf. Includes Slotted Backstop.

NOTES:

- Dividers sold separately. See page 18.
- If End Panels are used with Sloped Base Shelf, consult factory for End Panel dimension.

PLAIN ADJUSTABLE SHELVES*

ACTUAL SHELF DEPTH	CATALOG NO.
6"	CSPB-3606
7"	CSPB-3607
8"	CSPB-3608
9"	CSPB-3609
10"	CSPB-3610
11"	CSPB-3611
12"	CSPB-3612
15"	CSPB-3615

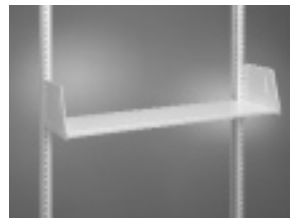

All shelves include End Brackets.

ADJUSTABLE SHELVES WITH INTEGRAL LOW-BACK*

ACTUAL SHELF DEPTH	CATALOG NO.
6"	CLBSB-3606
7"	CLBSB-3607
8"	CLBSB-3608
9"	CLBSB-3609
10"	CLBSB-3610
11"	CLBSB-3611
12"	CLBSB-3612
15"	CLBSB-3615



Integral Low-Back Shelves are compatible with Integral Low-Back Dividers.

NOTE:

- Integral Low-Back Dividers (Catalog No. CLBDxx) sold separately. See page 19 for corresponding Integral Low-Back Dividers.

* 24" and 30" shelf widths are available.

SPACE SAVER
LIBRARY SHELVING

Adjustable Shelves / Specialty Shelves

SLOTTED ADJUSTABLE SHELVES*

ACTUAL SHELF DEPTH	CATALOG NO.
6"	CSSB-3606
7"	CSSB-3607
8"	CSSB-3608
9"	CSSB-3609
10"	CSSB-3610
11"	CSSB-3611
12"	CSSB-3612
15"	CSSB-3615



Slotted on 1" centers for Dividers. Includes Slotted Backstop.

NOTES:

- Dividers sold separately. For Dividers, see page 18.
- Change dash (-) to "N" for narrow backstop when using a reference shelf.

SLOPED PLAIN ADJUSTABLE SHELVES*

ACTUAL SHELF DEPTH	CATALOG NO.
6"	CSPB-3606SL
7"	CSPB-3607SL
8"	CSPB-3608SL
9"	CSPB-3609SL
10"	CSPB-3610SL
11"	CSPB-3611SL
12"	CSPB-3612SL
15"	CSPB-3615SL

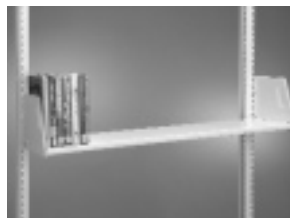

Sloped for easier viewing of displayed items.

NOTE:

- If End Panels are used with Sloped Shelf, consult factory for End Panel dimension.

* Shelves include End Brackets. 24" and 30" shelf widths are available. Change the catalog number accordingly, e.g., CSPB-2410. Adjustable Shelves may be used as Base Shelves in conjunction with the Adjustable Kick Plates.

SLOPED ADJUSTABLE SHELVES WITH INTEGRAL LOW BACK*

ACTUAL SHELF DEPTH	CATALOG NO.
6"	CLBSB-3606SL
7"	CLBSB-3607SL
8"	CLBSB-3608SL
9"	CLBSB-3609SL
10"	CLBSB-3610SL
11"	CLBSB-3611SL
12"	CLBSB-3612SL
15"	CLBSB-3615SL



Sloped to aid viewing of displayed items. Integral Low-Back Shelves are compatible with Integral Low-Back Dividers.

NOTES:

- Integral Low-Back Dividers (Catalog No. CLBDxx) sold separately. See page 19 for corresponding Integral Low-Back Divider.
- If End Panels are used with Sloped Shelf, consult factory for End Panel dimension.

SLOPED SLOTTED ADJUSTABLE SHELVES*

ACTUAL SHELF DEPTH	CATALOG NO.
6"	CSSB-3606SL
7"	CSSB-3607SL
8"	CSSB-3608SL
9"	CSSB-3609SL
10"	CSSB-3610SL
11"	CSSB-3611SL
12"	CSSB-3612SL
15"	CSSB-3615SL



Sloped to aid viewing of displayed items. Includes Slotted Backstop.

NOTES :

- Dividers sold separately. For Dividers, see page 18.
- If End Panels are used with Sloped Shelf, consult factory for End Panel dimension.

PERIODICAL DISPLAY SHELF (HINGED)

ACTUAL SHELF DEPTH/DISPLAY	CATALOG NO.
12"/14"	CHPD3612
12"/14" (SPECIAL 3" BASE)	CHPD33612

NOTES:

- The vertical opening between the flat shelf and the hinged display shelf (in the open position) is 6" clear.
- Recommend minimum 14" vertical center-to-center spacing.
- Front retaining lip is 1" deep.

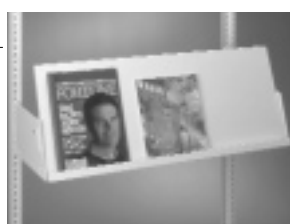

Sloped display surface (with no exposed fasteners) is 14" high. Flat storage shelf is 12" deep.

FIXED DISPLAY SHELF

ACTUAL SHELF DEPTH	FRONT LIP SIZE	CATALOG NO.
11"	1"	CFPS1-3611
11"	2"	CFPS2-3611
11"	3"	CFPS3-3611

NOTE:

- Recommend minimum 11" vertical center-to-center spacing.



11" high, sloped display surface for merchandising of books, tapes and periodicals.

PERIODICAL DISPLAY SHELF (HINGED) WITH PLEXIGLAS COVERS

ACTUAL SHELF DEPTH/DISPLAY	CATALOG NO.
12"/14"	CHPSC-3612
12"/14" (SPECIAL 3" BASE)	CHPSC3-3612

NOTE:

- The vertical opening between the flat shelf and the hinged display shelf (in the open position) is 6" clear.
- Recommend minimum 14" vertical center-to-center spacing.
- Front retaining lip is 1" deep.



Sloped display is 14" high. Flat storage shelf is 12" deep.

FLAT STORAGE SHELF

ACTUAL SHELF DEPTH	CATALOG NO.
11"	CFSSB3611
12"	CFSSB3612
15"	CFSSB3615



Includes End Brackets. Can be used for storage under the Fixed Display Shelf.

Specialty Shelves (Continued)

PULL-OUT REFERENCE SHELF

ACTUAL SHELF WIDTH/DEPTH	TO BE USED WITH SHELF DEPTH	CATALOG NO.
32"/9"	8"	CSRS-3609-08
32"/9"	9"	CSRS-3609-09
32"/11"	10"	CSRS-3611-10
32"/11"	11"	CSRS-3611-11
32"/11"	12"	CSRS-3611-12
32"/11"	15"	CSRS-3611-15

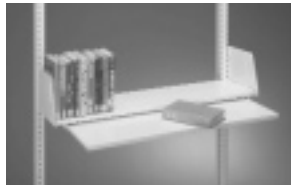

For convenient referencing, Pull-Out Reference Shelf has a 50 lb. load capacity.

NOTES:

- Requires minimum 1" clear space underneath stationary shelf.
- Order Shelf separately.
- Must use narrow backstop.

VHS, CD & PAPERBACK SHELF

ACTUAL SHELF DEPTH	CATALOG NO.
6	CPV-3606

NOTE:

- When storing standard VHS tapes upright, recommend a minimum 10" vertical center-to-center spacing.

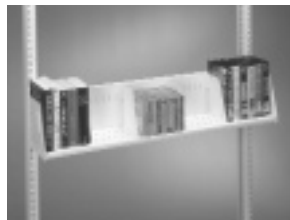

Slotted on 1" centers. Includes one (1) Slotted Backstop and four (4) Dividers per shelf. Each shelf holds approximately 26 VHS tapes or 80 CDs.

2 TIER, SLOPED VHS & CD SHELF

OVERALL SHELF DEPTH	ACTUAL END BRACKET HEIGHT	CATALOG NO.
14"	11"	CVCD3615DT

NOTES:

- When storing standard VHS tapes on the second tier, recommend a minimum of 17" vertical center-to-center spacing.
- Also in 24" and 30" widths. Change the catalog no. accordingly, e.g.: CVCD2415DT.
- Use CDB-14 base support.

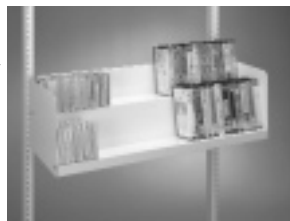

Each 36" wide shelf holds approximately 56 VHS tapes (28 per tier) or 168 CDs (84 per tier). Sloped to aid viewing.

VHS & CD WIRE RACK

ACTUAL RACK DEPTH	CATALOG NO.
6"	CVHSCD-R-36

NOTE:

- When storing standard VHS tapes, recommend a minimum of 10" vertical center-to-center spacing.

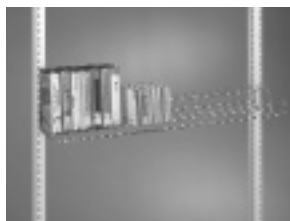

One VHS & CD Wire Rack holds 26 VHS tapes or 78 CDs.

2 TIER AUDIO CASSETTE TAPE SHELF

ACTUAL SHELF DEPTH	OVERALL SHELF HEIGHT	CATALOG NO.
6"	7"	CATASB-3606 (Adjustable)
6"	10"	CATBSB-3606 (Base)

NOTES:

- Recommend a minimum 11" vertical center-to-center spacing.
- Also in 24" and 30" widths. Change the catalog no. accordingly, e.g., CATASB-3006.



Each 36" wide shelf holds approximately 100 audio cassette tapes (50 per tier).

2 TIER MICROFILM SHELF

ACTUAL SHELF DEPTH	OVERALL SHELF HEIGHT	CATALOG NO.
9"	7"	CMSS-3609 (Adjustable)
9"	10"	CMSSB-3609 (Base)

NOTE:

- Recommend a minimum 10" vertical center-to-center spacing.

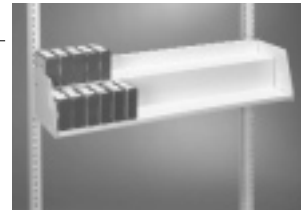

Each 36" wide shelf holds approximately 40 - 1 3/4" w. x 4" d. x 4" h. microfilm boxes (20 per tier).

MULTIMEDIA BROWSING BOX

DEPTH	HEIGHT	CATALOG NO.
12"	6 1/4"	CBBM3612

NOTES:

- Includes black, non-skid floor mat.
- CHWS-67 "Snap-In" Wire Dividers sold separately. See page 19.
- When storing standard VHS tapes, recommend a minimum of 10" vertical center-to-center spacing.



Each 36" wide unit stores approximately 42 VHS tapes or 100 CDs. Shown here accepting Snap-In Wire Dividers, catalog no. CHWS-67.

1 TIER MULTIMEDIA BROWSING BOX (DIVIDER-TYPE)

DEPTH	HEIGHT	CATALOG NO.
12"	6 1/4"	CBB3612SMM

NOTES:

- Includes one black, non-skid floor mat.
- Dividers sold separately. See below for CMMD955 Dividers.
- When storing standard VHS tapes, recommend a minimum 10" vertical center-to-center spacing.



2 TIER MULTIMEDIA BROWSING BOX (DIVIDER-TYPE)

DEPTH	HEIGHT	CATALOG NO.
15"	8 1/2"	CBB3615SMMDT

NOTES:

- Includes two black, non-skid floor mats.
- Dividers sold separately. See below for CMMD568 Dividers.
- When storing standard VHS tapes, recommend a minimum 12" vertical center-to-center spacing.



MULTIMEDIA BROWSING BOX DIVIDERS

FOR BROWSING BOX TYPE	CATALOG NO.
1 TIER (CBB3612SMM)	CMMD955
2 TIER (CBB3615SMMDT)	CMMD568

MEDIA	QUANTITY OF DIVIDERS PER TIER
CD'S	5
VHS TAPES	5
MICROFILM BOXES	7
AUDIO CASSETTE TAPES	11

SPACE SAVER LIBRARY SHELVING

Accessories

ZIGZAG DISPLAY BACKSTOP

HEIGHT	CATALOG NO.
3 ³ / ₄ "	CZBS-36

NOTE:
• Includes Backstop and fasteners only.
Order Shelf separately.



For merchandising a variety of audio-visual and paperback media.

DIVIDERS

ACTUAL SHELF DEPTH	CATALOG NO.
6"	CFD-6
7"	CFD-7
8"	CFD-8
9"	CFD-9
10"	CFD-10
11"	CFD-11
12"	CFD-12
15"	CFD-15



Dividers are all 6" high.

CENTERSTOP* (Offset for back-to-back shelving)

HEIGHT	CATALOG NO.
3 ³ / ₄ "	CCS-36

NOTE:
• Order Shelves separately

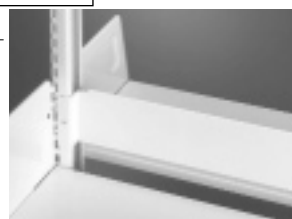

Eliminates the need for individual backstops.

6 TIER NEWSPAPER RACK

CATALOG NO.
CNR615

NOTE:
• For 36" newspaper sticks. Newspaper sticks not included.



Display up to 6 newspapers.

PLAIN BACKSTOP* (Narrow)

HEIGHT	CATALOG NO.
3 ³ / ₄ "	CABP36

NOTE:
• Order Shelf separately.



Order one (1) per shelf.

MEDIA BAG RACK

WILL ACCOMMODATE MEDIA BAGS UP TO	ACTUAL END BRACKET SHELF DEPTH	SHELF DEPTH	CATALOG NO.
12" deep	10"	6"	CMHR3610
20" deep	12"	10"	CMHR3612

NOTE:
• Media bags not included.



Hang large or small media bags on this 36" rod. Includes deflection inhibiting low-back shelf, clip and end brackets.

SLOTTED BACKSTOP* (Narrow)

HEIGHT	CATALOG NO.
3 ³ / ₄ "	CABS36

NOTE:
• Order Shelf separately.



Order one (1) per shelf.

STEEL BOOK SUPPORTS

A. FINDABLE BOOK SUPPORT
Eliminates searching for book supports between books.

HEIGHT	PAD TYPE	CATALOG NO.
6"	With full cork base	CBE-06NL
9"	With full cork base	CBE-09NL
10"	With full cork base	CBE-10NL
6"	With magnetic base	CBE-06NLM
9"	With magnetic base	CBE-09NLM
10"	With magnetic base	CBE-10NLM

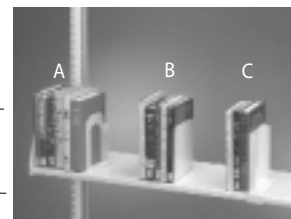

PLAIN BACKSTOP* (Full height)

HEIGHT	CATALOG NO.
6"	CPBS-36



Interlocks with shelf. Order one (1) per shelf.

B. FLAT BOOK END
Place media on top of the Flat Book End for support.

HEIGHT	CATALOG NO.
4"	CACD-4
6"	CBE-06
9"	CBE-09

NOTE:
• Includes full cork base.

C. CLIP ON BOOK SUPPORT
Easy to locate the "Clip-On" Book Support since it clips on the shelf front.

HEIGHT	CATALOG NO.
6"	CCOD6
9"	CCOD9

NOTE:
• Includes full cork base.

SLOTTED BACKSTOP* (Full height)

HEIGHT	CATALOG NO.
6"	CSBS-36



Interlocks with shelf. Order one (1) per shelf.

*24" and 30" widths available.

Accessories (Continued)

"W" HANGING WIRE SUPPORT (Squeeze Type)

ACTUAL SHELF DEPTH	CATALOG NO.
8" & 9"	CWWS08
10" & 11"	CWWS10
12"	CWWS12

NOTE:

- If used with Canopy Tops, order "W" Type Canopy Tops.



Available in three (3) sizes for five (5) different shelf depths.

"SNAP IN" HANGING WIRE BOOK SUPPORT

ACTUAL SHELF DEPTH	CATALOG NO.
6" & 7"	CHWS-67*
8" & 9"	CHWS-89
10", 11" & 12"	CHWS-1012
15"	CHWS-15

NOTE:

- * CHWS-67 also works with Multimedia Browsing Box, catalog no. CBBM3612.



The "Snap In" Hanging Wire Book Supports come in four (4) different sizes.

INTEGRAL LOW-BACK DIVIDERS (For Integral Low-Back Shelves)

ACTUAL SHELF DEPTH	CATALOG NO.
8" & 9"	CLBD08
10", & 11"	CLBD10
12"	CLBD12

NOTE:

- Order Integral Low-Back Shelf separately.

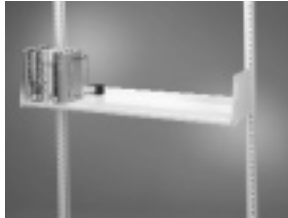

Available in three (3) sizes for five (5) different shelf depths.

RANGE FINDER & CARD HOLDERS

TYPE	SIZE	CATALOG NO.
A. Range Finder	3"H x 5"D	RFST35
B. Continuous Card Holder	4"H	CSIHww
(Where "ww" is the actual End Panel width, e.g. Use CSIH20 for a 20" wide End Panel.)		
C. 3x5 Card Holder	3"H x 5"D	CHST35

NOTES:

- A & B available in the color to match the color of shelving ordered.
- C available in black finish.
- B & C include double-back tape.



SHELF LABEL HOLDERS

TYPE	WIDTH	CATALOG NO.
A. Clear Plastic Label Holder	5"	CLH-05
B. Magnetic Label Holder	36"	LH-36

NOTE:

- Both A & B include paper label inserts.



CANOPY TOP*

SINGLE FACE

OVERALL TOP DEPTH	ACTUAL SHELF DEPTH	CATALOG NO.
8"	6"	CCTSB-3606
9"	7"	CCTSB-3607
10"	8"	CCTSB-3608
11"	9"	CCTSB-3609
12"	10"	CCTSB-3610
13"	11"	CCTSB-3611
14"	12"	CCTSB-3612
17"	15"	CCTSB-3615



Includes mounting brackets.

*Not a weight bearing shelf.

DOUBLE FACE

OVERALL TOP DEPTH	ACTUAL SHELF DEPTH	CATALOG NO.
14"	6"	CCTDB-3606
16"	7"	CCTDB-3607
18"	8"	CCTDB-3608
20"	9"	CCTDB-3609
22"	10"	CCTDB-3610
24"	11"	CCTDB-3611
26"	12"	CCTDB-3612
32"	15"	CCTDB-3615

NOTE:

- Not compatible with "W" Hanging Wire Dividers. When "W" Hanging Wire Dividers are used, change "-" to "W" for a Canopy Top which will accommodate "W" Hanging Wire Dividers, e.g., CCTDBW3609.

CANOPY LIGHT

WIDTH	DEPTH	CATALOG NO.
36"	20 1/2"	CCLIGHT3621

NOTES:

- Internal, UL listed 24" light fixture accepts 2-24" long bulbs.
- Bulbs not included.
- Light housing is 12 3/8" deep and 5" high.



Illuminate display shelves or brighten dimly lit alcoves. Includes white prismatic diffuser.

BRACKETS FOR LAMINATED CANOPY TOP

ACTUAL OVERALL TOP DEPTH	LEFT END CATALOG NO.	RIGHT END CATALOG NO.
6", 7" & 8"	CCTBL-6L	CCTBL-6R
9", 10", 11", 12" & 15"	CCTBL-15L	CCTBL-15R

NOTE:

- Order left and right brackets separately. In the above photo, one CCTBL-15L and one CCTBL-15R are shown in conjunction with a 20" deep (overall) laminated canopy top which was designed to accommodate actual 9" deep shelves.



Fasteners included.

BASE SHELF FILLER*

SHELF WIDTH	CATALOG NO.
36"	CBSF-36
(For use with 3" Base Shelf.)	
36"	CBSF1-36
(For use with 1" Base Shelf.)	

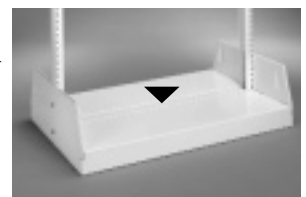

Fills the space between the two back-to-back Base Shelves.

*24" and 30" widths available.

SPACE SAVER
LIBRARY SHELVING

Accessories (Continued) / Options

ADJUSTABLE SHELF FILLER*

SHELF WIDTH	CATALOG NO.
36"	CASF36

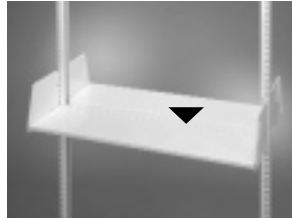

Fills the space between two back-to-back Adjustable Shelves.

ADJUSTABLE KICK PLATES*

KICK PLATE TYPE	CATALOG NO.
RECESSED**	CKP36
FLUSH (Not Shown)	CFKP36

NOTES:

- Adjustable, Flush Kick Plate not shown.
- ** Base supports must be 1" less than shelf depth when using Adjustable Recessed Kick Plate.
- Both types include mounting hardware.
- Both may be used with or without levelers.
- Requires an additional 1" of frame height when used with no leveler kits.

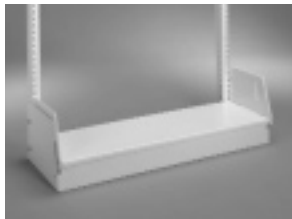

Adjustable Kick Plates may be used when Adjustable Shelves are used as Base Shelves.

*24" and 30" widths available.

INTERMEDIATE WALL FILLERS

CATALOG NO.
CIF-dsdddsh

NOTE:

- ds = overall depth of the single face unit in inches (including the 2" frame)
- dd = overall depth of the double face unit in inches (including the 2" frame)
- ht = height of the adjoining Welded Frame, e.g., CIF-11201184 (for shelves with an actual depth of 9").



Fills the rectangular void created when two single face sections are placed at a right angle with a double face section. Specify overall unit depths (ds & dd) and frame height used (ht).

LEVELER KITS

SINGLE FACE

NO. OF LEVELING FEET PER KIT	ACTUAL BASE SUPPORT DEPTHS	CATALOG NO.
3	8", 9" & 10"	CSFL0608
4	11", 12", 13", 14" & 17"	CSFL0915

DOUBLE FACE

NO. OF LEVELING FEET PER KIT	ACTUAL BASE SUPPORT DEPTHS	CATALOG NO.
4	14", 16" & 18"	CDFL0608
6	20", 22", 24", 26" & 32"	CDFL0915

NOTE:

- Order one (1) kit per base support .



Use when floor is out of level.

WALL ATTACHMENT BRACKET

CATALOG NO.
CWAB

NOTE:

- Fastening hardware not included since wall material may vary.

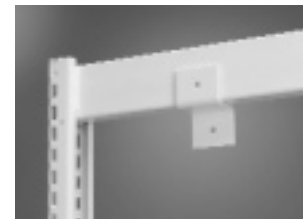

For attaching single face Welded Frames to a wall.

CORNER FILLERS

CATALOG NO.
CCF-dsdsht

NOTE:

- ds = overall depth of the single face unit in inches (including the 2" frame)
- ht = height of the adjoining Welded Frame, e.g., CCF-111184 (for shelves with an actual depth of 9").

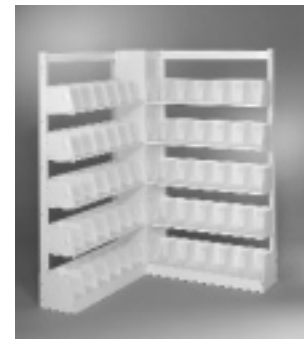

Fills the corner void created when single face sections are placed at right angles. Specify overall unit depths (dsds) and frame height used (ht).

Options (Continued)

METAL END PANELS

SINGLE FACE

ACTUAL SHELF DEPTH	CATALOG NO.
42" UPRIGHT HEIGHT	
6"	CRMEP4208
7"	CRMEP4209
8"	CRMEP4210
9"	CRMEP4211
10"	CRMEP4212
11"	CRMEP4213
12"	CRMEP4214
15"	CRMEP4217
66" UPRIGHT HEIGHT	
6"	CRMEP6608
7"	CRMEP6609
8"	CRMEP6610
9"	CRMEP6611
10"	CRMEP6612
11"	CRMEP6613
12"	CRMEP6614
15"	CRMEP6617
78" UPRIGHT HEIGHT	
6"	CRMEP7808
7"	CRMEP7809
8"	CRMEP7810
9"	CRMEP7811
10"	CRMEP7812
11"	CRMEP7813
12"	CRMEP7814
15"	CRMEP7817
84" UPRIGHT HEIGHT	
6"	CRMEP8408
7"	CRMEP8409
8"	CRMEP8410
9"	CRMEP8411
10"	CRMEP8412
11"	CRMEP8413
12"	CRMEP8414
15"	CRMEP8417
90" UPRIGHT HEIGHT	
6"	CRMEP9008
7"	CRMEP9009
8"	CRMEP9010
9"	CRMEP9011
10"	CRMEP9012
11"	CRMEP9013
12"	CRMEP9014
15"	CRMEP9017

DOUBLE FACE

ACTUAL SHELF DEPTH	CATALOG NO.
42" UPRIGHT HEIGHT	
6"	CRMEP4214D
7"	CRMEP4216D
8"	CRMEP4218D
9"	CRMEP4220D
10"	CRMEP4222D
11"	CRMEP4224D
12"	CRMEP4226D
15"	CRMEP4232D
66" UPRIGHT HEIGHT	
6"	CRMEP6614D
7"	CRMEP6616D
8"	CRMEP6618D
9"	CRMEP6620D
10"	CRMEP6622D
11"	CRMEP6624D
12"	CRMEP6626D
15"	CRMEP6632D
78" UPRIGHT HEIGHT	
6"	CRMEP7814D
7"	CRMEP7816D
8"	CRMEP7818D
9"	CRMEP7820D
10"	CRMEP7822D
11"	CRMEP7824D
12"	CRMEP7826D
15"	CRMEP7832D
84" UPRIGHT HEIGHT	
6"	CRMEP8414D
7"	CRMEP8416D
8"	CRMEP8418D
9"	CRMEP8420D
10"	CRMEP8422D
11"	CRMEP8424D
12"	CRMEP8426D
15"	CRMEP8432D
90" UPRIGHT HEIGHT	
6"	CRMEP9014D
7"	CRMEP9016D
8"	CRMEP9018D
9"	CRMEP9020D
10"	CRMEP9022D
11"	CRMEP9024D
12"	CRMEP9026D
15"	CRMEP9032D



Use to finish off the exposed ends of shelving ranges. Metal End Panels are 1- 1/2" thick.

NOTES:

- End Panels should be sized to cover the overall base depth. (overall base shelf depth = actual shelf depth + 2" frame.)
- End Panel Mounting Brackets sold separately. See page 22.

SPACE SAVER
LIBRARY SHELVING

Options (Continued)

END PANEL MOUNTING BRACKETS

SINGLE FACE

ACTUAL SHELF DEPTH	CATALOG NO.
6"	CMEPSS08L
6"	CMEPSS08R
7"	CMEPSS09L
7"	CMEPSS09R
8"	CMEPSS10L
8"	CMEPSS10R
9"	CMEPSS11L
9"	CMEPSS11R
10"	CMEPSS12L
10"	CMEPSS12R
11"	CMEPSS13L
11"	CMEPSS13R
12"	CMEPSS14L
12"	CMEPSS14R
15"	CMEPSS17L
15"	CMEPSS17R

DOUBLE FACE

ACTUAL SHELF DEPTH	CATALOG NO.
6"	CMEPSD14
7"	CMEPSD16
8"	CMEPSD18
9"	CMEPSD20
10"	CMEPSD22
11"	CMEPSD24
12"	CMEPSD26
15"	CMEPSD32



For use on both Metal End Panels and Laminate End Panels when Canopy Top is not used. Double face bracket shown.

NOTE:
• Order one (1) per End Panel.

CLOSED BACK KITS

FRAME HEIGHT	CATALOG NO.
42"	CBPF-4236
66"	CBPF-6636
78"	CBPF-7836
84"	CBPF-8436
90"	CBPF-9036



Fills the space between the upright frame. Kits include two (2) Upright Fillers (hidden from view).

NOTE:
• Also available in 24" and 30" widths. Change the catalog no. accordingly, e.g.: CBPF-4224.

CLOSURE PANELS

END PANEL WIDTH	CATALOG NO.
7 8" FRAME HEIGHT	
8" SINGLE FACE	CCP-0878
9" SINGLE FACE	CCP-0978
10" SINGLE FACE	CCP-1078
11" SINGLE FACE	CCP-1178
12" SINGLE FACE	CCP-1278
13" SINGLE FACE	CCP-1378
14" SINGLE FACE	CCP-1478S
17" SINGLE FACE	CCP-1778
14" DOUBLE FACE	CCP-1478D
16" DOUBLE FACE	CCP-1678
18" DOUBLE FACE	CCP-1878
20" DOUBLE FACE	CCP-2078
22" DOUBLE FACE	CCP-2278
24" DOUBLE FACE	CCP-2478
26" DOUBLE FACE	CCP-2678
32" DOUBLE FACE	CCP-3278
8 4" FRAME HEIGHT	
8" SINGLE FACE	CCP-0884
9" SINGLE FACE	CCP-0984
10" SINGLE FACE	CCP-1084
11" SINGLE FACE	CCP-1184
12" SINGLE FACE	CCP-1284
13" SINGLE FACE	CCP-1384
14" SINGLE FACE	CCP-1484S
17" SINGLE FACE	CCP-1784
14" DOUBLE FACE	CCP-1484D
16" DOUBLE FACE	CCP-1684
18" DOUBLE FACE	CCP-1884
20" DOUBLE FACE	CCP-2084
22" DOUBLE FACE	CCP-2284
24" DOUBLE FACE	CCP-2484
26" DOUBLE FACE	CCP-2684
32" DOUBLE FACE	CCP-3284

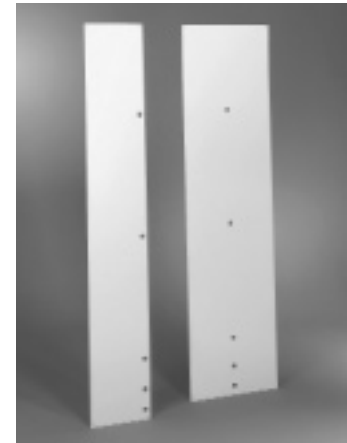

May be used to enclose backside of the End Panels. Match the End Panel size.

END PANEL WIDTH	CATALOG NO.
9 0" FRAME HEIGHT	
8" SINGLE FACE	CCP-0890
9" SINGLE FACE	CCP-0990
10" SINGLE FACE	CCP-1090
11" SINGLE FACE	CCP-1190
12" SINGLE FACE	CCP-1290
13" SINGLE FACE	CCP-1390
14" SINGLE FACE	CCP-1490S
17" SINGLE FACE	CCP-1790
14" DOUBLE FACE	CCP-1490D
16" DOUBLE FACE	CCP-1690
18" DOUBLE FACE	CCP-1890
20" DOUBLE FACE	CCP-2090
22" DOUBLE FACE	CCP-2290
24" DOUBLE FACE	CCP-2490
26" DOUBLE FACE	CCP-2690
32" DOUBLE FACE	CCP-3290

